

Proportional pressure reducing cartridge

- ◆ pilot operated
- ◆ $Q_{\max} = 40 \text{ l/min}$
- ◆ $p_{\max} = 400 \text{ bar}$
- ◆ $p_{N \text{ red max}} = 350 \text{ bar}$

DESCRIPTION

Pilot operated proportional pressure reducing valve in screw-in cartridge construction for cavity according to ISO 7789. Proportionally to the solenoid current, the solenoid force and the pressure in port A (1) rise. The valve functions practically independently of the pressure in port P (2). Pressure increase in the consumer port A (1) to above the adjusted value, e.g. through an active consumer, is avoided by discharging excess oil to the tank T (3). With the solenoid deenergised, the oil flows freely from consumer port A (1) to port T (3). For the control, Wandfluh proportional amplifiers are available (see register 1.13). The pressure tight encapsulated Ex-protection solenoid coil prevents an explosion on the inside penetrating to the outside as well as an ignitable surface temperature.

SYMBOL

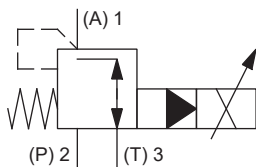

GENERAL SPECIFICATIONS

Designation	Proportional pressure reducing valve
Construction	Pilot operated
Mounting	Screw-in cartridge construction
Nominal size	M22 x 1,5 according to ISO 7789
Actuation	Proportional solenoid
Ambient temperature	Operation as T4 -25...+70 °C (L15 / L17)
Weight	2,2 kg
MTTFd	150 years

M22 x 1,5 ISO 7789

- ⊕ II 2 G Ex db IIC T6, T4
- ⊕ II 2 D Ex tb III C T80 °C, T130 °C
- ⊕ I M2 Ex db I Mb
- Class I Division 1
- Class I Zone 1

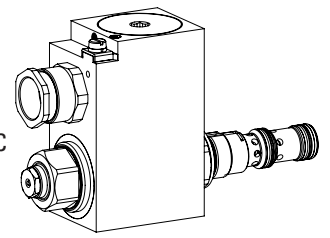

APPLICATION

These valves are suitable for applications in explosion-hazard areas, open cast and also in mines. The electrical remote control in conjunction with process controls allows economical solutions with repeatable processes. The screw-in cartridge is perfectly suitable for installation in control blocks and is installed in sandwich- (vertical stacked systems) and in flange plates (corresponding data sheets in this register). For machining the cartridge cavity in steel and aluminum blocks, cavity tools are available (hire or purchase). Please refer to the data sheets in register 2.13.

CERTIFICATES

	Surface	Mining	Standard -25 °C to...	M248 Electronic
ATEX	x	x	x	x
IECEx	x	x	x	x
CCC	x	x	x	x
EAC	x	x	x	x
Australia	x	x	x	
MA		x	x	x
UL / CSA	x		x	

The certificates can be found on www.wandfluh.com

ACTUATION

Actuation	Proportional solenoid, wet pin push type, pressure tight
Execution	MKY45 / 18x60 (data sheet 1.1-183) MKU45 / 18x60 (data sheet 1.1-184)
Connection	Cable gland for cable Ø 6,5... 14 mm

Attention! The UL execution is always supplied without cable gland



TYPE CODE

		M Q B PM22 - <input type="text"/> - <input type="text"/> / <input type="text"/> / <input type="text"/> - <input type="text"/> <input type="text"/> # <input type="text"/>			
Pressure reducing valve					
Pilot operated					
Proportional					
Screw-in cartridge M22 x 1,5					
Nominal pressure range p_{Nred}	40 bar	<input type="text" value="40"/>	200 bar	<input type="text" value="200"/>	
	63 bar	<input type="text" value="63"/>	275 bar	<input type="text" value="275"/>	
	100 bar	<input type="text" value="100"/>	350 bar	<input type="text" value="350"/>	
	160 bar	<input type="text" value="160"/>			
Nominal voltage U_N	12 VDC	<input type="text" value="G12"/>			
	24 VDC	<input type="text" value="G24"/>			
Nominal power P_N	15 W	<input type="text" value="L15"/>	<i>Ambient temperature up to:</i>		
	17 W	<input type="text" value="L17"/>	70 °C		
			70 °C (only UL / CSA)		
Certification	ATEX, IECEx, EAC,	<input type="text"/>	UL / CSA	<input type="text" value="UL"/>	
	CCC		MA	<input type="text" value="MA"/>	
	Australia	<input type="text" value="AU"/>			
Sealing material	NBR	<input type="text"/>			
	FKM (Viton)	<input type="text" value="D1"/>			
Options	without amplifier	<input type="text"/>			
		<input type="text" value="M248"/>			
Design index (subject to change)					
2.3-644					

ELECTRICAL SPECIFICATIONS

Protection class	IP65 / 66 / 67
Relative duty factor	100 % DF
Voltage tolerance	± 10 % with regard to nominal voltage
Standard nominal voltage	12 VDC, 24 VDC
Limiting current at 50 °C	L15 / 17, 50 °C $I_G = 950 \text{ mA}$ (12 VDC) $I_G = 450 \text{ mA}$ (24 VDC) L15 / 17, 70 °C $I_G = 910 \text{ mA}$ (12 VDC) $I_G = 420 \text{ mA}$ (24 VDC)
Standard nominal power	15 W, 17 W
Temperature class	Nominal power 15 W / 17 W: T1...T4

Note! Other electrical specifications see data sheet 1.1-183 and 1.1-184



HYDRAULIC SPECIFICATIONS

Working pressure	$p_{max} = 400 \text{ bar}$
Tank pressure	$p_{Tmax} = p_p + 20 \text{ bar}$
Supply pressure	$p_p \geq p_{red} + 10 \text{ bar}$ (static) $p_p \geq p_{red} + 80 \text{ bar}$ (at 40 l/min)
Nominal pressure range	$p_{Nred} = 40; 63; 100; 160; 200; 275; 350 \text{ bar}$
Minimum adjustable pressure	Static < 1 bar adjustable
Volume flow range	$Q = 0 \dots 40 \text{ l/min}$
Leakage oil	See characteristics
Hysteresis	≤ 5 % at optimal dither signal
Repeatability	≤ 3 % at optimal dither signal
Fluid	Mineral oil, other fluid on request
Viscosity range	12 mm ² /s...320 mm ² /s
Temperature range fluid	Operation as T4 NBR -25...+70 °C (L15 / L17) FKM -20...+70 °C (L15 / L17)
Contamination efficiency	Class 18 / 16 / 13
Filtration	Required filtration grade $\beta_{6...10} \geq 75$, see data sheet 1.0-50

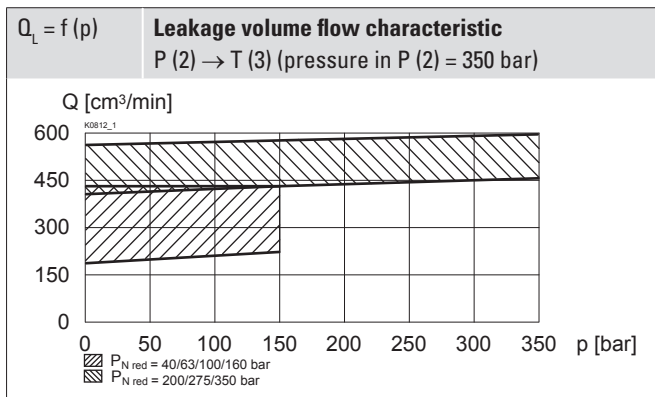
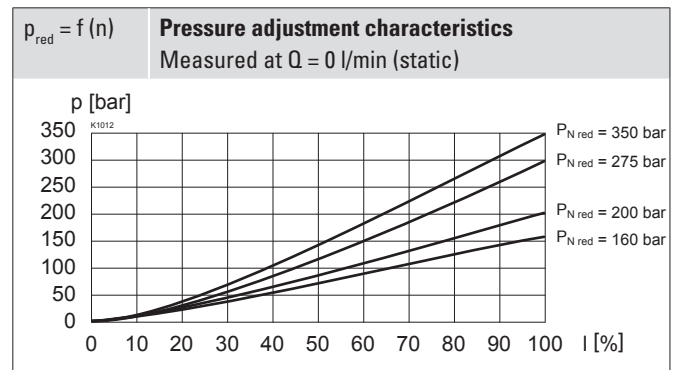
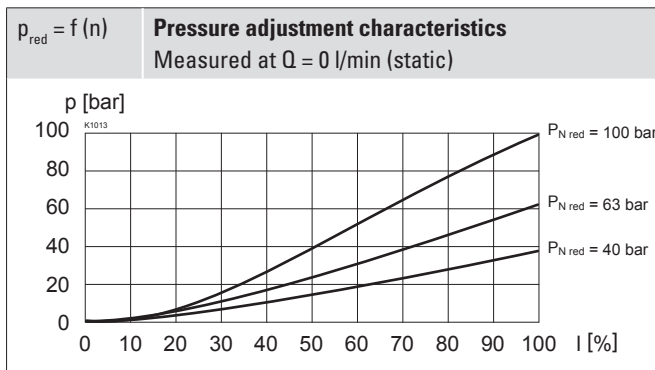
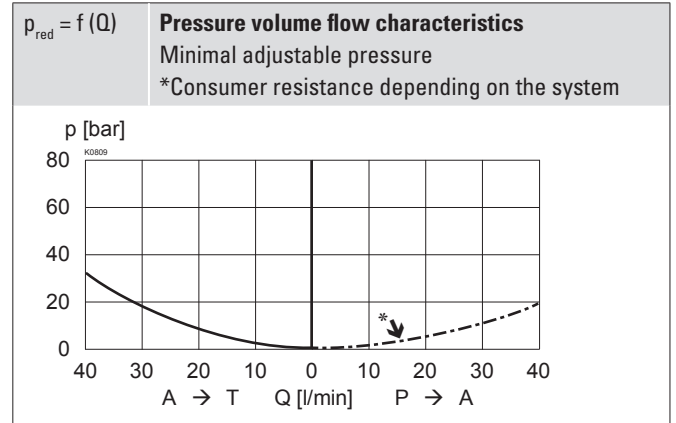
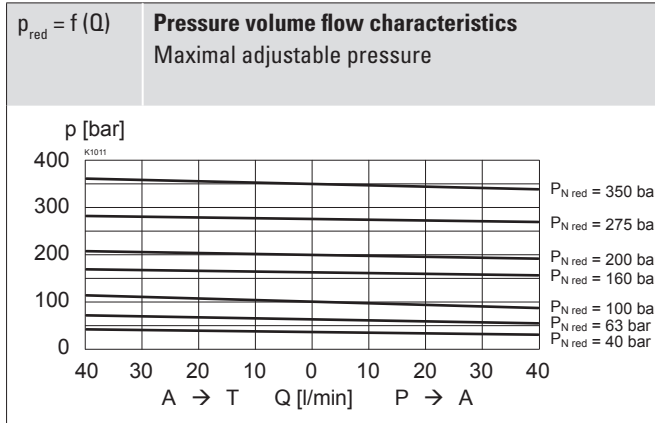
PERFORMANCE SPECIFICATIONS

 Oil viscosity $\nu = 30 \text{ mm}^2/\text{s}$

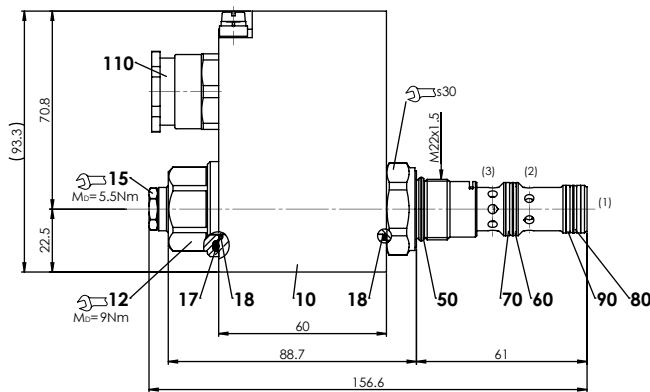
DIMENSIONS



HYDRAULIC CONNECTION

Cavity drawing according to ISO 7789-22-04-0-98

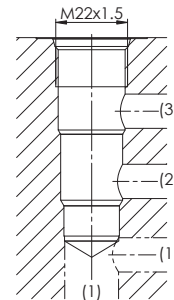

Note!



For detailed cavity drawing and cavity tools see data sheet 2.13-1004

PARTS LIST

Position	Article	Description
10	263.6...	Solenoid coil MK.45 / 18 x 60
12	154.2603	Knurled nut Ex M18 x 1,5 x 18
15	253.8000	Manual override HB4,5
17	160.2251	O-ring ID 25,07 x 2,62 (NBR)
18	160.2170	O-ring ID 17,17 x 1,78 (NBR)
50	160.2188	O-ring ID 18,77 x 1,78 (NBR)
	160.6188	O-ring ID 18,77 x 1,78 (FKM)
60	160.2156	O-ring ID 15,60 x 1,78 (NBR)
	160.6156	O-ring ID 15,60 x 1,78 (FKM)
70	049.3196	Backup ring rd 16,1 x 19 x 1,4
80	160.2140	O-ring ID 14,00 x 1,78 (NBR)
	160.6141	O-ring ID 14,00 x 1,78 (FKM)
90	049.3176	Backup ring rd 14,1 x 17 x 1,4
110	111.1080	Cable gland M20 x 1,5

STANDARDS

Cartridge cavity	ISO 7789
Explosion protection	Directive 2014 / 34 / EU (ATEX)
Flameproof enclosure	EN / IEC / UL 60079-1, 31
Cable entry	EN 60079-0, 1, 7, 15, 31
Protection class	EN 60 529
Contamination efficiency	ISO 4406

INSTALLATION NOTES

Mounting type	Screw-in cartridge M22 x 1,5
Mounting position	Any, preferably horizontal
Tightening torque	$M_D = 60$ Nm Screw-in cartridge $M_D = 9$ Nm knurled nut $M_D = 9,5$ Nm HB0 $M_D = 5,5$ Nm HB4,5

Attention! For stack assembly please observe the remarks in the operating instructions



ACCESSORIES

Proportional amplifier	Register 1.13
Flange body / sandwich plate NG4-Mini	Data sheet 2.3-820
Flange body / sandwich plate NG6	Data sheet 2.3-840
Flange body / sandwich plate NG10	Data sheet 2.3-860
Threaded body	Data sheet 2.9-210
Technical explanations	Data sheet 1.0-100
Filtration	Data sheet 1.0-50

MANUAL OVERRIDE

HB4,5 as standard

SEALING MATERIAL

NBR or FKM (Viton) as standard, choice in the type code

SURFACE TREATMENT

◆ The cartridge body, the slip-on coil and the armature tube are zinc-nickel coated

COMMISSIONING

Attention! The solenoid coil must only be put into operation, if the requirements of the operating instructions supplied are observed to their full extent. In case of non-observance, no liability can be assumed.



Wandfluh AG Postfach CH-3714 Frutigen
 Tel. +41 33 672 72 72 Fax +41 33 672 72 12 sales@wandfluh.com