

Proportional pressure reducing cartridge

- ◆ direct operated
- ◆ $Q_{max} = 6 \text{ l/min}$
- ◆ $p_{max} = 210 \text{ bar (350 bar)}$
- ◆ $p_{N \text{ red max}} = 100 \text{ bar}$

DESCRIPTION

Direct operated proportional pressure reducing valve in screw-in cartridge construction for cavity according to Wandfluh standard. Proportionally to the solenoid current, the solenoid force and the pressure in port A (1) rise. The valve functions practically independently of the pressure in port P (2). Pressure increase in the consumer port A (1) to above the adjusted value, e.g. through an active consumer, is avoided by discharging excess oil to the tank T (3). With the solenoid deenergised, the oil flows freely from consumer port A (1) to port T (3). For the control, Wandfluh proportional amplifiers are available (see register 1.13). The pressure tight encapsulated Ex-protection solenoid coil prevents an explosion on the inside penetrating to the outside as well as an ignitable surface temperature.

SYMBOL

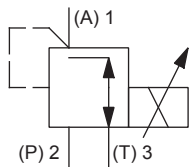

GENERAL SPECIFICATIONS

Designation	Proportional pressure reducing valve
Construction	Direct operated
Mounting	Screw-in cartridge construction
Nominal size	M16 x 1,5 according to Wandfluh standard
Actuation	Proportional solenoid
Ambient temperature	Operation as T4 -25...+70 °C (L15 / L17)
Weight	2,2 kg
MTTFd	150 years

M16 x 1,5

Wandfluh standard

- ⊕ II 2 G Ex db IIC T6, T4
- ⊕ II 2 D Ex tb III C T80 °C, T130 °C
- ⊕ I M2 Ex db I Mb
- Class I Division 1
- Class I Zone 1

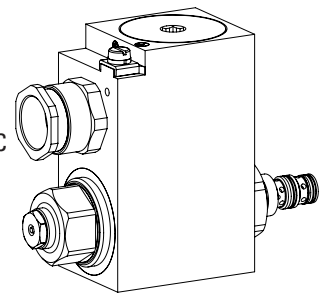

APPLICATION

These valves are suitable for applications in explosion-hazard areas, open cast and also in mines. The electrical remote control in conjunction with process controls allows economical solutions with repeatable processes. For machining the cartridge cavity in steel and aluminum blocks, cavity tools are available (hire or purchase). Please refer to the data sheets in register 2.13.

CERTIFICATES

	Surface	Mining	Standard -25 °C to...	M248 Electronic
ATEX	x	x	x	x
IECEX	x	x	x	x
CCC	x	x	x	x
EAC	x	x	x	x
Australia	x	x	x	
MA		x	x	x
UL / CSA	x		x	

The certificates can be found on www.wandfluh.com

ACTUATION

Actuation	Proportional solenoid, wet pin push type, pressure tight
Execution	MKY45 / 18x60 (data sheet 1.1-183) MKU45 / 18x60 (data sheet 1.1-184)
Connection	Cable gland for cable Ø 6,5...14 mm

Attention! The UL execution is always supplied without cable gland



TYPE CODE

		M G B PM16 - 100 - <input type="text"/> / <input type="text"/> / <input type="text"/> - <input type="text"/> <input type="text"/> <input type="text"/> # <input type="text"/>	
Pressure reducing valve			
Direct operated			
Proportional, explosion proof execution Ex d			
Screw-in cartridge M16 x 1,5			
Nominal pressure range $p_{N\text{red}}$	100 bar		
Nominal voltage U_N	12 VDC	<input type="text" value="G12"/>	
	24 VDC	<input type="text" value="G24"/>	
Nominal power P_N	15 W	<input type="text" value="L15"/>	Ambient temperature up to: 70 °C 70 °C (only UL / CSA)
	17 W	<input type="text" value="L17"/>	
Certification	ATEX, IECEx, EAC, CCC	<input type="text"/>	UL / CSA
	Australia	<input type="text" value="AU"/>	MA
			<input type="text" value="UL"/> <input type="text" value="MA"/>
Sealing material	NBR	<input type="text"/>	
	FKM (Viton)	<input type="text" value="D1"/>	
Options	without amplifier	<input type="text"/>	
		<input type="text" value="M248"/>	
	System pressure max. 210 bar	<input type="text"/>	
	System pressure max. 350 bar	<input type="text" value="Z406"/>	
Design index (subject to change)			

2.3-608

ELECTRICAL SPECIFICATIONS

Protection class	IP65 / 66 / 67
Relative duty factor	100 % DF
Voltage tolerance	± 10 % with regard to nominal voltage
Standard nominal voltage	12 VDC, 24 VDC
Limiting current at 50 °C	L15 / 17, 50 °C
	$I_G = 950 \text{ mA}$ (12 VDC)
	$I_G = 450 \text{ mA}$ (24 VDC)
	L15 / 17, 70 °C
	$I_G = 910 \text{ mA}$ (12 VDC)
	$I_G = 420 \text{ mA}$ (24 VDC)
Standard nominal power	15 W, 17 W
Temperature class	Nominal power 15 W / 17 W: T1...T4

Note! Other electrical specifications see data sheet 1.1-183 and 1.1-184



HYDRAULIC SPECIFICATIONS

Working pressure	$p_{\text{max}} = 210 \text{ bar}$ (350 bar)
Nominal pressure range	$p_{N\text{red}} = 100 \text{ bar}$
Minimum adjustable pressure	< 0,5 bar
Volume flow range	$Q = 0 \dots 6 \text{ l/min}$
Leakage oil	$p_{\text{sys}} = 160 \text{ bar}$
	$p_{\text{red}} = 0 \text{ bar}$: < 15 ml/min
	$p_{\text{red}} = 0,5 \times p_{N\text{red}}$: < 60 ml/min
Hysteresis	≤ 4 % at optimal dither signal
Repeatability	≤ 1 % at optimal dither signal
Fluid	Mineral oil, other fluid on request
Viscosity range	12 mm ² /s...320 mm ² /s
Temperature range fluid	Operation as T4
	NBR -25...+70 °C (L15 / L17)
	FKM -20...+70 °C (L15 / L17)
Contamination efficiency	Class 18 / 16 / 13
Filtration	Required filtration grade $\beta_{6 \dots 10} \geq 75$, see data sheet 1.0-50

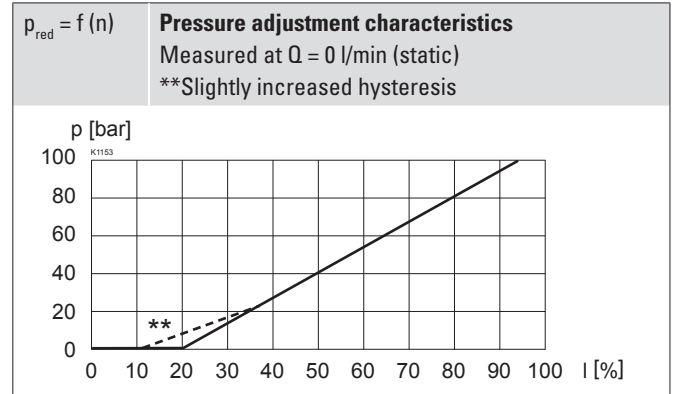
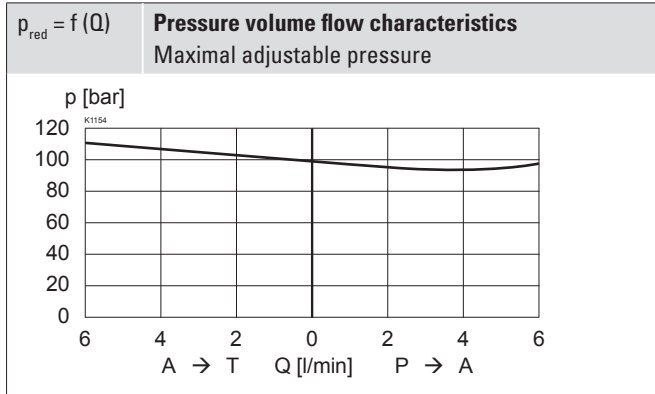
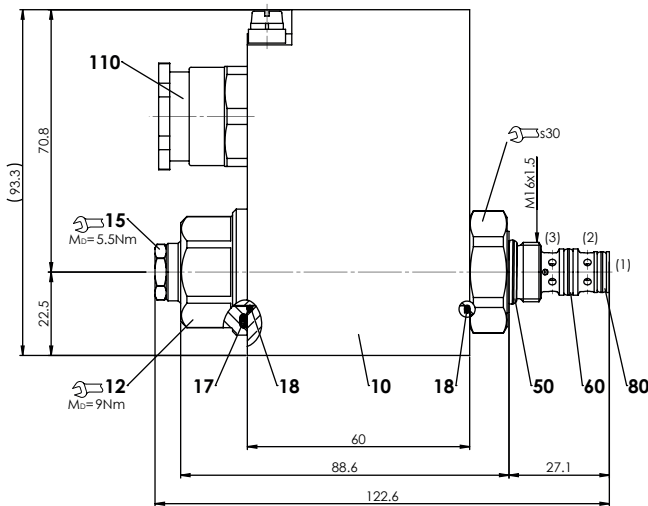
PERFORMANCE SPECIFICATIONS

 Oil viscosity $\nu = 30 \text{ mm}^2/\text{s}$

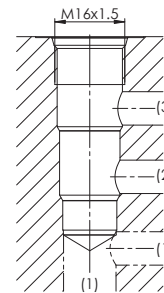
DIMENSIONS

HYDRAULIC CONNECTION

Cavity drawing according to Wandfluh standard

Attention! For detailed cavity drawing and cavity tools see data sheet 2.13-1051

PARTS LIST

Position	Article	Description
10	263.6...	Solenoid coil MK.45 / 18 x 60
12	154.2603	Knurled nut Ex M18 x 1,5 x 18
15	253.8000	Manual override HB4,5
17	160.2187	O-ring ID 18,72 x 2,62 (NBR)
18	160.2170	O-ring ID 17,17 x 1,78 (NBR)
50	160.2140	O-ring ID 14,00 x 1,78 (NBR)
	160.8140	O-ring ID 14,00 x 1,78 (FKM)
60	160.2093	O-ring ID 9,25 x 1,78 (NBR)
	160.8092	O-ring ID 9,25 x 1,78 (FKM)
80	160.2076	O-ring ID 7,65 x 1,78 (NBR)
	160.8076	O-ring ID 7,65 x 1,78 (FKM)
110	111.1080	Cable gland M20 x 1,5

ACCESSORIES

Proportional amplifier	Register 1.13
Technical explanations	Data sheet 1.0-100
Filtration	Data sheet 1.0-50

MANUAL OVERRIDE

HB4,5 as standard

SURFACE TREATMENT

- ◆ The cartridge body is gas-nitro carburised
- ◆ The slip-on coil and the armature tube are zinc-nickel coated

STANDARDS

Cartridge cavity	Wandfluh standard
Explosion protection	Directive 2014 / 34 / EU (ATEX)
Flameproof enclosure	EN / IEC / UL 60079-1, 31
Cable entry	EN 60079-0, 1, 7, 15, 31
Protection class	EN 60 529
Contamination efficiency	ISO 4406

COMMISSIONING

Attention!  The solenoid coil must only be put into operation, if the requirements of the operating instructions supplied are observed to their full extent. In case of non-observance, no liability can be assumed.

SEALING MATERIAL

NBR or FKM (Viton) as standard, choice in the type code

INSTALLATION NOTES

Mounting type	Screw-in cartridge type M16 x 1,5
Mounting position	Any, preferably horizontal
Tightening torque	$M_D = 30$ Nm screw-in cartridge $M_D = 9$ Nm Knurled nut