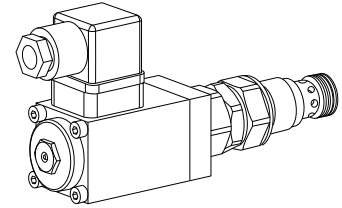

**Pressure relief valve solenoid operated
Screw-in cartridge**

- Pilot operated
- $Q_{max} = 100$ l/min
- $p_{max} = 400$ bar
- $p_{Nmax} = 350$ bar

M22x1,5
 ISO 7789

DESCRIPTION

Pilot operated pressure relief valve, solenoid activated with mechanical pressure adjustment. With activated solenoid the valve will shift to maximum adjusted pressure. Screw-in cartridge with M22x1,5 thread, in accordance with ISO 7789. Standard pressure ranges: 63, 160, 350 bar. The solenoid is used to either activate or deactivate the valve, and may be rotated through 360°. Solenoid power = 18 W. External parts are zinc coated or phosphated. Caution: Standard solenoids with 22Watt power consumption may not be used on this valve.

FUNCTION

The valve consists of a main stage and integrated pilot stage. When working pressure setting is reached main spool opens and connects pressure port with tank port. The spring in the pilot stage can easily be adjusted by means of a hexagon nut. With de-energised solenoid the valve is in unloading mode. This pilot operated pressure relief valve can be adjusted very sensitively and is suitable for large oil flows and high pressures. This device is concerning hydraulic performance equal to the pilot operated pressure relief valve BV.PM22.

APPLICATION

For limiting the operating pressure in hydraulic systems. Oil will be relieved from protected line P to return line T. The solenoid for loading and unloading allows remote control of the system pressure. The Screw-in cartridge is ideally suited for installation in HIC blocks and is also utilised in Wandfluhs range of NG4, NG6 and NG10 sandwich and flange mounted valves. See data sheet register No 2.1 Cavity tools are available for hire or sale for machining aluminium or steel. See data sheet register No 2.13. **Attention:** Should therefore not be utilised anymore in applications with periodically changing direction of flow.

TYPE CODE

Pressure relief valve	B	V	E	PM22	-		-		#	
Pilot operated										
Electric operated										
Screw-in cartridge M22x1,5										
Nominal pressure range p_N	63 bar	<input type="text" value="63"/>								
	160 bar	<input type="text" value="160"/>								
	350 bar	<input type="text" value="350"/>								
Nominal voltage U_N / nominal power P_N										
12VDC/18W	<input type="text" value="G12"/>		110VAC/18W	<input type="text" value="R110"/>						
24VDC/18W	<input type="text" value="G24"/>		115VAC/18W	<input type="text" value="R115"/>						
			230VAC/18W	<input type="text" value="R230"/>						
Design-Index (Subject to change)										

GENERAL SPECIFICATIONS

Denomination	Pilot operated pressure relief valve solenoid operated
Construction	Screw-in cartridge for cavity acc. to ISO 7789
Mounting	Screw-in thread M22x1,5
Mounting position	any
Ambient temperature	-20...+50°C
Weight	m = 0.76 kg
Fastening torque	$M_D = 50$ Nm for cartridge $M_D = 2,8$ Nm (Qual. 8.8) for fastening screws of solenoid

HYDRAULIC SPECIFICATIONS

Fluid	Mineral oil, other fluid on request
Contamination efficiency	ISO 4406:1999, class 18/16/13 (Required filtration grade $\beta_{6...10} \geq 75$) refer to data sheet 1.0-50/2
Viscosity range	12 mm ² /s...320 mm ² /s
Fluid temperature	-20...+70°C
Peak pressure	$p_{max} = 400$ bar $p_{Tmax} = p_p + 20$ bar
Nominal pressure	$p_N = 63$ bar, $p_N = 160$ bar, $p_N = 350$ bar Note: Max. adjustable pressure may exceed nominal pressure by up to 30% depending on production tolerances
Minimal pressure	see characteristics
Volume flow	$Q = 0,2...100$ l/min
Leakage volume flow	see characteristics

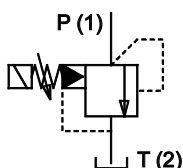
SYMBOL

ELECTRICAL SPECIFICATIONS

Design	Solenoid, wet pin push type, pressure tight
Nominal voltage	$U_N = 12 \text{ VDC}, 24 \text{ VDC}$ $U_N = 110 \text{ VAC}^*, 115 \text{ VAC}^*, 230 \text{ VAC}^*$ AC = 50 to 60 Hz * Connector plug with integrated rectifier
Voltage tolerance	$\pm 10\%$ of nominal voltage.
Protection class	IP 65 according to EN 60 529
Relative duty factor	100% ED (See data sheet 1.1-430)
Switching cycles	15'000/h
Operating life (number of switching cycles)	10^7
Connection/Power supply	Over device plug connection to ISO 4400/DIN 43650, (2P+E), other connections on request
Solenoid type:	- Medium SIN35V (data sheet 1.1-105)

OPERATING PRESSURE

The desired operating pressure is set by means of a knob and is only reached with the solenoid activated. By-pass circulation is obtained when the solenoid is switched to no current.

Pressure adjustment:	
Actuation stroke	$S_b = 2,5 \text{ mm}$
Actuation angle	$\alpha_b = 1080^\circ$ (3 revolutions)

CHARACTERISTICS Oil viscosity $\nu = 30 \text{ mm}^2/\text{s}$

$p = f(Q)$ Pressure volume flow characteristics (Maximal adjustable pressure)

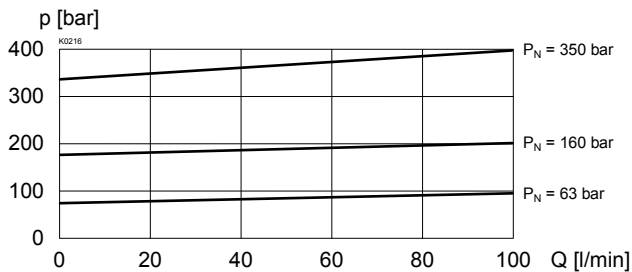

$p = f(Q)$ Pressure volume flow characteristics (Minimal adjustable pressure)

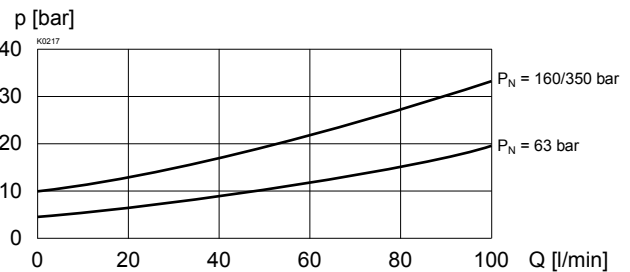

$p = f(n)$ Pressure adjustment characteristics (at $Q = 5 \text{ l/min}$)

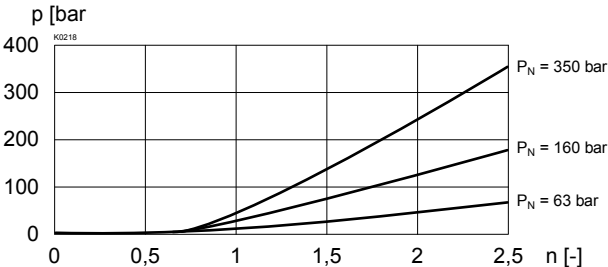

$Q_L = f(p)$ Leakage volume flow characteristics $P(1) \rightarrow T(2)$

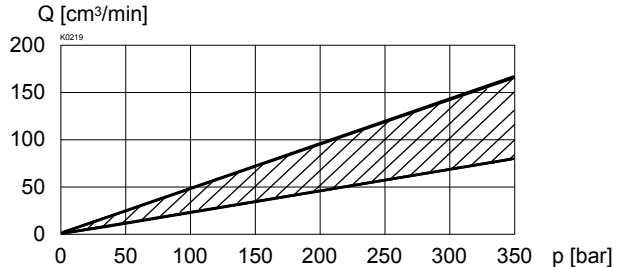
SECTIONAL DRAWING/PRESSURE ADJUSTMENT

For detailed cavity drawing ISO 7789-22-02-0-98 and cavity tools see data sheet 2.13-1003

Pressure is only adjustable with activated solenoid.

- 1) Loose lock nut **A**
- 2) Turn knob **B** and solenoid until required system pressure is adjusted
- 3) Fix turning knob **B** with lock nut **A**
- 4) Loose screws **C** slightly, turn solenoid into required position.
(Attention: Solenoid stays under tank pressure.)
- 5) Tighten screws **C** with torque ($M_D, 2,8 \text{ Nm}$)

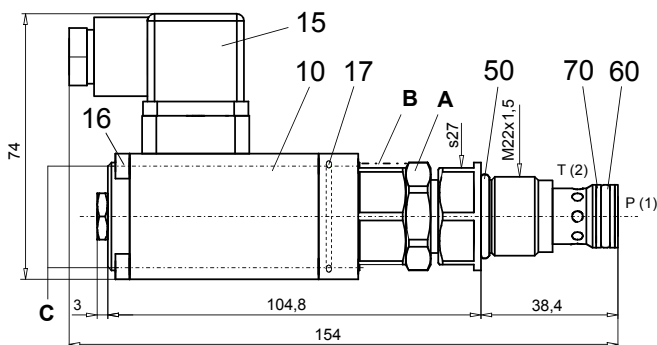
PARTS LIST

Position	Article	Description
10	260.4...	Solenoid SIN35V-... -L18
15	219.2002	Plug (black)
16	249.1007	Socket head screw M4 x 63
17	160.2283	O-ring ID 28,3 x 1,78
50	160.2188	O-ring ID 18,77 x 1,78
60	160.2140	O-ring ID 14,00 x 1,78
70	049.3177	Back-up ring RD 14,6 x 17,5 x 1,4

ACCESSORIES

Flange-/sandwich plate NG4-Mini	Data sheet 2.1-620
Flange-/sandwich plate NG6	Data sheet 2.1-640
Flange-/sandwich plate NG10	Data sheet 2.1-660
Line mount body	Data sheet 2.9-200

Technical explanation see data sheet 1.0-100