

## Spool valve

### Flange construction

- ◆ hand operated
- ◆ 4/3-way with spring centred mid position
- ◆ 4/2-way with spring reset
- ◆ 4/2- and 4/3-way detented
- ◆  $Q_{max} = 80$  l/min
- ◆  $p_{max} = 350$  bar

**NG6**  
**ISO 4401-03**

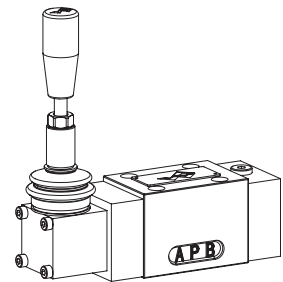

## DESCRIPTION

Direct operated spool valve, hand operated with 4 connections in 5 chamber design. Spool detented or with spring reset. Without actuation, the spool is held in the center position by the spring (4/3), or switched back to the offset position (4/2). With the detent, the spool is held in the last switching position selected. Precise spool fit, low leakage, long service life time. Spool made from hardened steel, valve body from high quality hydraulic cast steel.

## APPLICATION

Spool valves are mainly used for controlling direction of movement and stopping of hydraulic cylinders and motors. The direction of movement is determined by the position of the spool and its symbol. Manually or mechanically operated valves are particularly suitable for use in installations where no electric current is available or for applications in explosion hazard areas.

## TYPE CODE

Spool valve, direct operated		WD	<input type="checkbox"/>	F	A06	-	<input type="checkbox"/>	-	<input type="checkbox"/>	#	<input type="checkbox"/>
Hand lever with spring reset or spring centred		<input type="checkbox"/>	<input type="checkbox"/>	<input type="checkbox"/>	<input type="checkbox"/>	<input type="checkbox"/>	<input type="checkbox"/>	<input type="checkbox"/>	<input type="checkbox"/>	<input type="checkbox"/>	<input type="checkbox"/>
Hand lever detented		<input type="checkbox"/>	<input type="checkbox"/>	<input type="checkbox"/>	<input type="checkbox"/>	<input type="checkbox"/>	<input type="checkbox"/>	<input type="checkbox"/>	<input type="checkbox"/>	<input type="checkbox"/>	<input type="checkbox"/>
Flange construction		<input type="checkbox"/>	<input type="checkbox"/>	<input type="checkbox"/>	<input type="checkbox"/>	<input type="checkbox"/>	<input type="checkbox"/>	<input type="checkbox"/>	<input type="checkbox"/>	<input type="checkbox"/>	<input type="checkbox"/>
International standard interface ISO, NG6		<input type="checkbox"/>	<input type="checkbox"/>	<input type="checkbox"/>	<input type="checkbox"/>	<input type="checkbox"/>	<input type="checkbox"/>	<input type="checkbox"/>	<input type="checkbox"/>	<input type="checkbox"/>	<input type="checkbox"/>
Designation of symbols acc. to table	Operation a-side	<input type="checkbox"/>	<input type="checkbox"/>	<input type="checkbox"/>	<input type="checkbox"/>	<input type="checkbox"/>	<input type="checkbox"/>	<input type="checkbox"/>	<input type="checkbox"/>	<input type="checkbox"/>	<input type="checkbox"/>
	Operation b-side	<input type="checkbox"/>	<input type="checkbox"/>	<input type="checkbox"/>	<input type="checkbox"/>	<input type="checkbox"/>	<input type="checkbox"/>	<input type="checkbox"/>	<input type="checkbox"/>	<input type="checkbox"/>	<input type="checkbox"/>
Sealing material	NBR	<input type="checkbox"/>	<input type="checkbox"/>	<input type="checkbox"/>	<input type="checkbox"/>	<input type="checkbox"/>	<input type="checkbox"/>	<input type="checkbox"/>	<input type="checkbox"/>	<input type="checkbox"/>	<input type="checkbox"/>
	FKM (Viton)	<input type="checkbox"/>	<input type="checkbox"/>	<input type="checkbox"/>	<input type="checkbox"/>	<input type="checkbox"/>	<input type="checkbox"/>	<input type="checkbox"/>	<input type="checkbox"/>	<input type="checkbox"/>	<input type="checkbox"/>
	NBR 872	<input type="checkbox"/>	<input type="checkbox"/>	<input type="checkbox"/>	<input type="checkbox"/>	<input type="checkbox"/>	<input type="checkbox"/>	<input type="checkbox"/>	<input type="checkbox"/>	<input type="checkbox"/>	<input type="checkbox"/>
		<input type="checkbox"/>	<input type="checkbox"/>	<input type="checkbox"/>	<input type="checkbox"/>	<input type="checkbox"/>	<input type="checkbox"/>	<input type="checkbox"/>	<input type="checkbox"/>	<input type="checkbox"/>	<input type="checkbox"/>
Design index (subject to change)		<input type="checkbox"/>	<input type="checkbox"/>	<input type="checkbox"/>	<input type="checkbox"/>	<input type="checkbox"/>	<input type="checkbox"/>	<input type="checkbox"/>	<input type="checkbox"/>	<input type="checkbox"/>	<input type="checkbox"/>

1.5-41

## GENERAL SPECIFICATIONS

Designation	4/2-, 4/3-spool valve
Construction	Direct operated
Mounting	Flange construction
Nominal size	NG6 according to ISO 4401-03
Actuation	Hand operated
Ambient temperature	-25...+70 °C
Weight	1,9 kg
MTTFd	150 years

## HYDRAULIC SPECIFICATIONS

Working pressure	$p_{max} = 350$ bar
Tank pressure	$p_{Tmax} = 100$ bar
Maximum volume flow	$Q_{max} = 80$ l/min, see characteristics
Leakage oil	See characteristics
Fluid	Mineral oil, other fluid on request
Viscosity range	12 mm <sup>2</sup> /s...320 mm <sup>2</sup> /s
Temperature range fluid	-25...+70 °C (NBR) -20...+70 °C (FKM)
Contamination efficiency	Class 20 / 18 / 14
Filtration	Required filtration grade $\beta_{10...16} \geq 75$ , see data sheet 1.0-50

**SYMBOL**

**Overview valves**

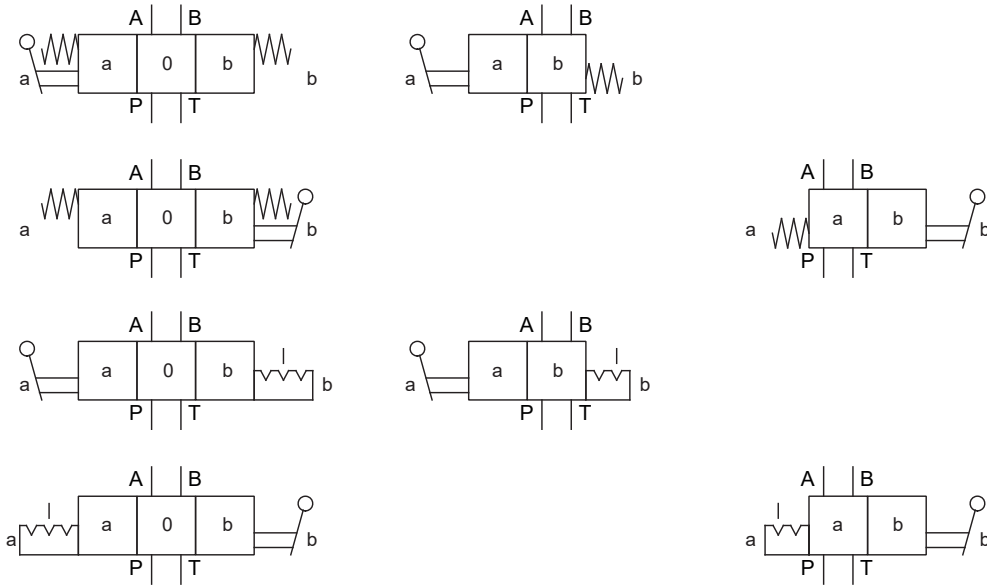

**Overview spool types**

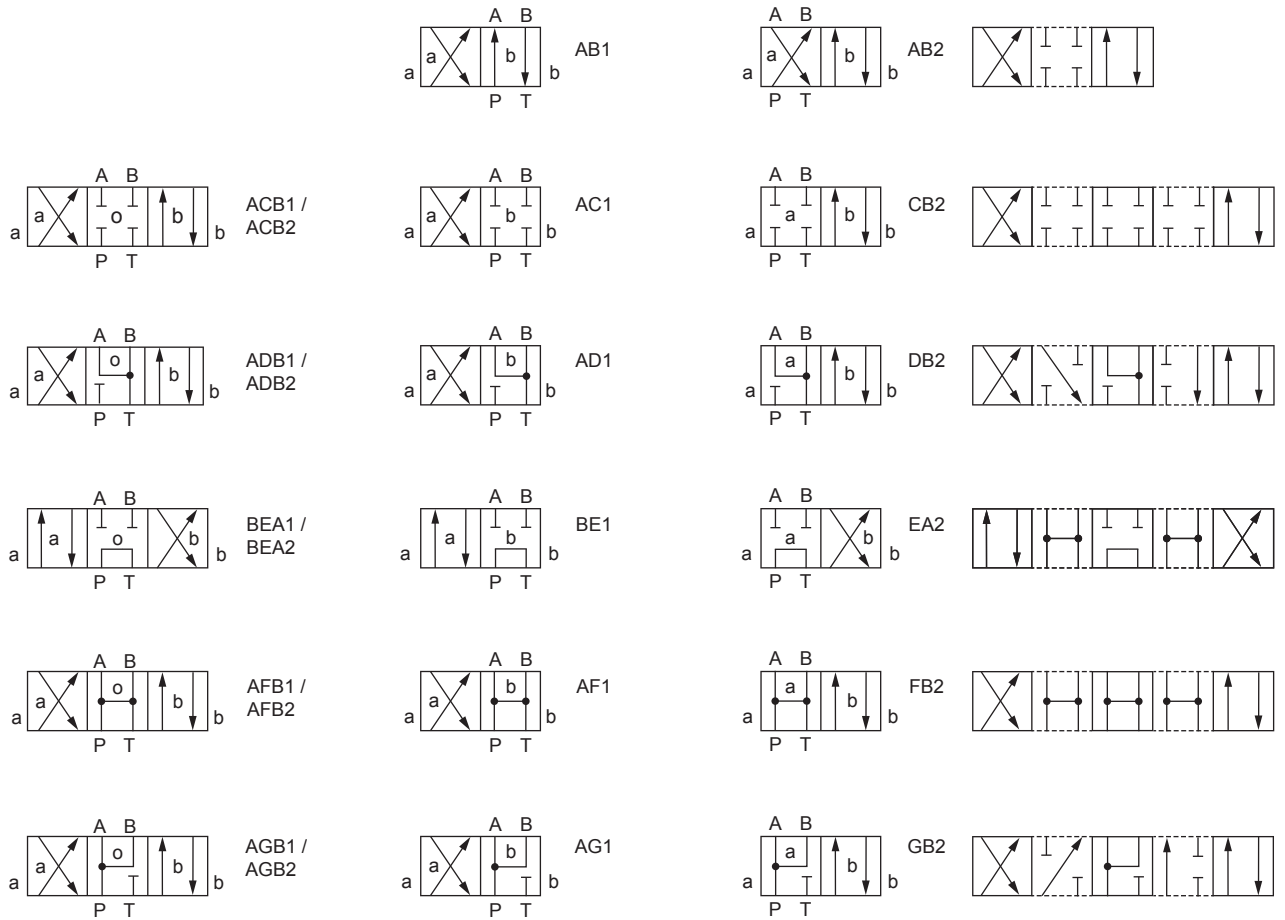

**PERFORMANCE SPECIFICATIONS**

Oil viscosity  $\nu = 30 \text{ mm}^2/\text{s}$

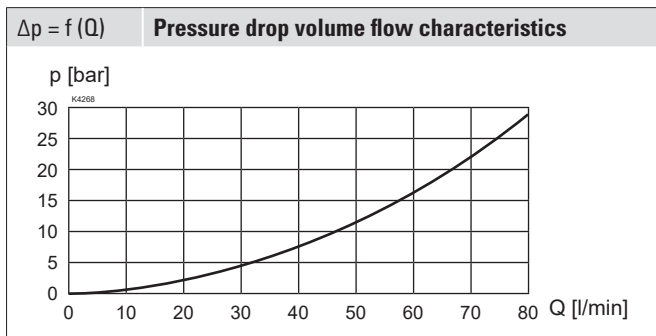
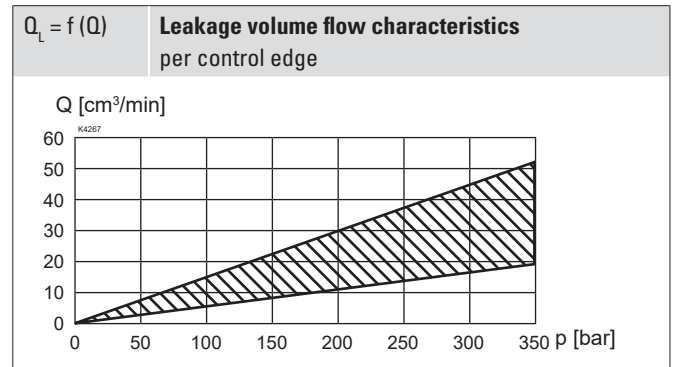
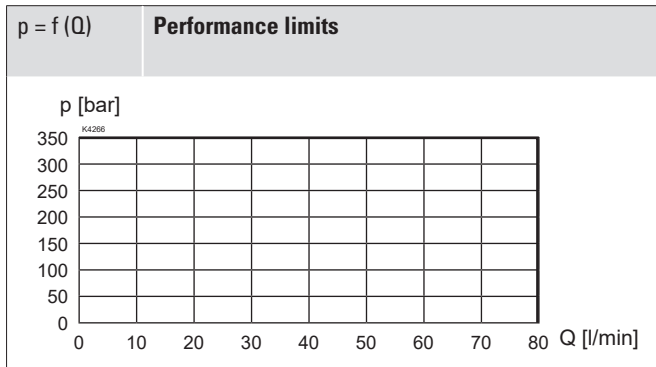

**DIMENSIONS**

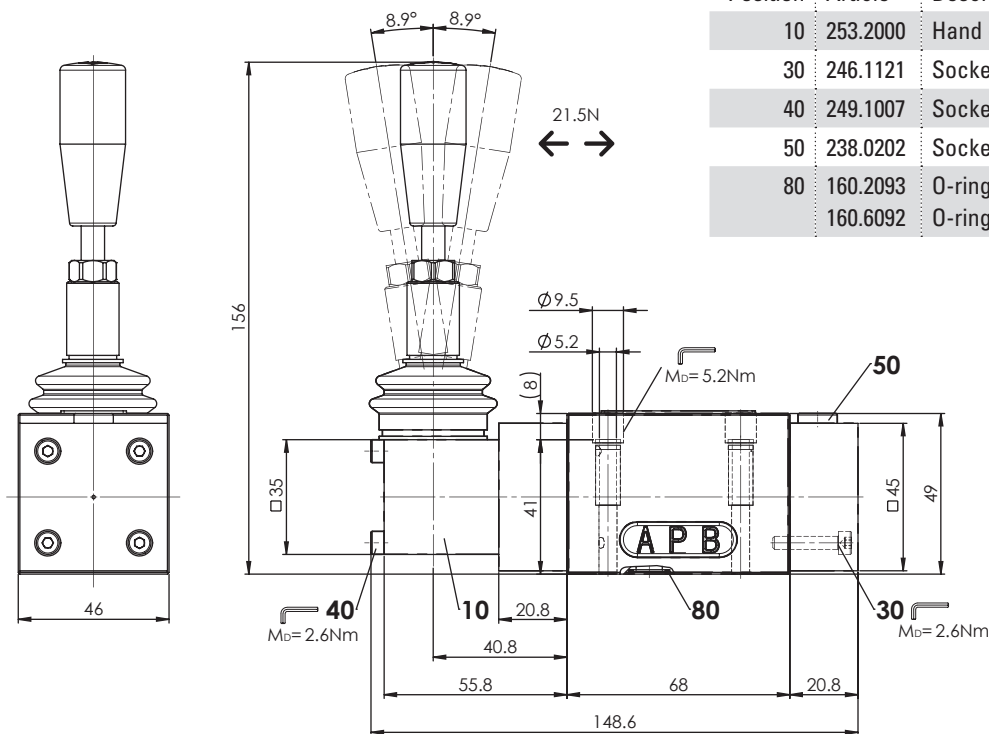

**PARTS LIST**

Position	Article	Description
10	253.2000	Hand control head BH11
30	246.1121	Socket head screw M4 x 20 DIN 912
40	249.1007	Socket head screw M4 x 63
50	238.0202	Socket head screw M8 x 1 DIN 908
80	160.2093	O-ring ID 9,25 x 1,78 (NBR)
	160.6092	O-ring ID 9,25 x 1,78 (FKM)

## HYDRAULIC CONNECTION

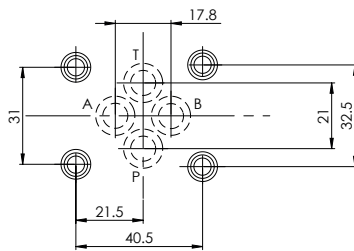

## ACTUATION

Actuation	Hand lever
Actuation angle	$\alpha_b = 8,9^\circ$ / side
Actuation force	$F_b = 21,5$ N

## INSTALLATION NOTES

Mounting type	Flange mounting 4 fixing holes for socket head screws M5 x 50
Mounting position	Any, preferably horizontal
Tightening torque	Fixing screws $M_b = 5,2$ Nm (screw quality 8.8, zinc coated)

### Note!



The length of the fixing screw depends on the base material of the connection element.

## ACCESSORIES

Fixing screws	Data sheet 1.0-60
Threaded subplates	Data sheet 2.9-30
Multi-station subplates	Data sheet 2.9-60
Horizontal mounting blocks	Data sheet 2.9-100
Technical explanations	Data sheet 1.0-100
Filtration	Data sheet 1.0-50

## STANDARDS

Mounting interface	ISO 4401-03
Contamination efficiency	ISO 4406

## SURFACE TREATMENT

- ◆ The valve body is painted with a two component paint
- ◆ The hand lever housing and the cover are zinc-nickel coated

## SEALING MATERIAL

NBR or FKM (Viton) as standard, choice in the type code