

Spool valve

Flange construction

- ◆ hand operated
- ◆ 4/3-way with spring centred mid position
- ◆ 4/2-way with spring reset
- ◆ 4/2- and 4/3-way detented
- ◆ $Q_{max} = 8 \text{ l/min}$
- ◆ $p_{max} = 350 \text{ bar}$

DESCRIPTION

Direct operated spool valve, hand operated with 4 connections in 5 chamber design. Spool detented or with spring. Without actuation, the spool is held in the center position by the spring (4/3), or switched back to the offset position (4/2). With the detent, the spool is held in the last switching position selected. Precise spool fit, low leakage, long service life time. Spool made from hardened steel, body from high quality hydraulic cast steel.

NG3-Mini

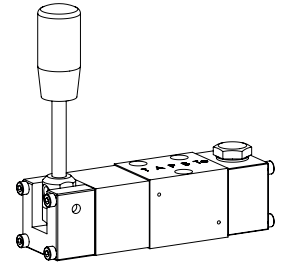

APPLICATION

Spool valves are mainly used for controlling direction of movement and stopping of hydraulic cylinders and motors. The direction of movement is determined by the position of the spool and its symbol. Manually or mechanically operated valves are particularly suitable for use in installations where no electric current is available or for applications in explosion hazard areas. Miniature valves are used where both, reduced dimensions and weight are important.

TYPE CODE

Spool valve, direct operated		WD	<input type="checkbox"/>	F	A03	-	<input type="checkbox"/>	-	<input type="checkbox"/>	#	<input type="checkbox"/>
Hand lever with spring reset or spring centred		<input type="checkbox"/>	<input type="checkbox"/>	<input type="checkbox"/>	<input type="checkbox"/>	<input type="checkbox"/>	<input type="checkbox"/>	<input type="checkbox"/>	<input type="checkbox"/>	<input type="checkbox"/>	<input type="checkbox"/>
Hand lever detented		<input type="checkbox"/>	<input type="checkbox"/>	<input type="checkbox"/>	<input type="checkbox"/>	<input type="checkbox"/>	<input type="checkbox"/>	<input type="checkbox"/>	<input type="checkbox"/>	<input type="checkbox"/>	<input type="checkbox"/>
Flange construction		<input type="checkbox"/>	<input type="checkbox"/>	<input type="checkbox"/>	<input type="checkbox"/>	<input type="checkbox"/>	<input type="checkbox"/>	<input type="checkbox"/>	<input type="checkbox"/>	<input type="checkbox"/>	<input type="checkbox"/>
Mounting interface acc. to Wandfluh standard, NG3-Mini		<input type="checkbox"/>	<input type="checkbox"/>	<input type="checkbox"/>	<input type="checkbox"/>	<input type="checkbox"/>	<input type="checkbox"/>	<input type="checkbox"/>	<input type="checkbox"/>	<input type="checkbox"/>	<input type="checkbox"/>
Designation of symbols acc. to table	Operation a-side	<input type="checkbox"/>	<input type="checkbox"/>	<input type="checkbox"/>	<input type="checkbox"/>	<input type="checkbox"/>	<input type="checkbox"/>	<input type="checkbox"/>	<input type="checkbox"/>	<input type="checkbox"/>	<input type="checkbox"/>
	Operation b-side	<input type="checkbox"/>	<input type="checkbox"/>	<input type="checkbox"/>	<input type="checkbox"/>	<input type="checkbox"/>	<input type="checkbox"/>	<input type="checkbox"/>	<input type="checkbox"/>	<input type="checkbox"/>	<input type="checkbox"/>
Sealing material	NBR	<input type="checkbox"/>	<input type="checkbox"/>	<input type="checkbox"/>	<input type="checkbox"/>	<input type="checkbox"/>	<input type="checkbox"/>	<input type="checkbox"/>	<input type="checkbox"/>	<input type="checkbox"/>	<input type="checkbox"/>
	FKM (Viton)	<input type="checkbox"/>	<input type="checkbox"/>	<input type="checkbox"/>	<input type="checkbox"/>	<input type="checkbox"/>	<input type="checkbox"/>	<input type="checkbox"/>	<input type="checkbox"/>	<input type="checkbox"/>	<input type="checkbox"/>
Design index (subject to change)		<input type="checkbox"/>	<input type="checkbox"/>	<input type="checkbox"/>	<input type="checkbox"/>	<input type="checkbox"/>	<input type="checkbox"/>	<input type="checkbox"/>	<input type="checkbox"/>	<input type="checkbox"/>	<input type="checkbox"/>

1.5-10

GENERAL SPECIFICATIONS

Designation	4/2-, 4/3-spool valve
Construction	Direct operated
Mounting	Flange construction
Nominal size	NG3-Mini according to Wandfluh standard
Actuation	Hand operated
Ambient temperature	-25...+70 °C (NBR) -20...+70 °C (FKM)
Weight	0,62 kg
MTTFd	150 years

HYDRAULIC SPECIFICATIONS

Working pressure	$p_{max} = 350 \text{ bar}$ ($p_r < 20 \text{ bar}$) $p_{max} = 315 \text{ bar}$ ($p_r > 20 \text{ bar}$)r
Tank pressure	$p_{Tmax} = 100 \text{ bar}$
Maximum volume flow	$Q_{max} = 8 \text{ l/min}$, see characteristics
Leakage volume flow	See characteristics
Fluid	Mineral oil, other fluid on request
Viscosity range	12 mm ² /s...320 mm ² /s
Temperature range	-25...+70 °C
fluid	
Contamination efficiency	Class 20 / 18 / 14
Filtration	Required filtration grade $\beta_{10...16} \geq 75$, see data sheet 1.0-50

SYMBOL

Overview valves

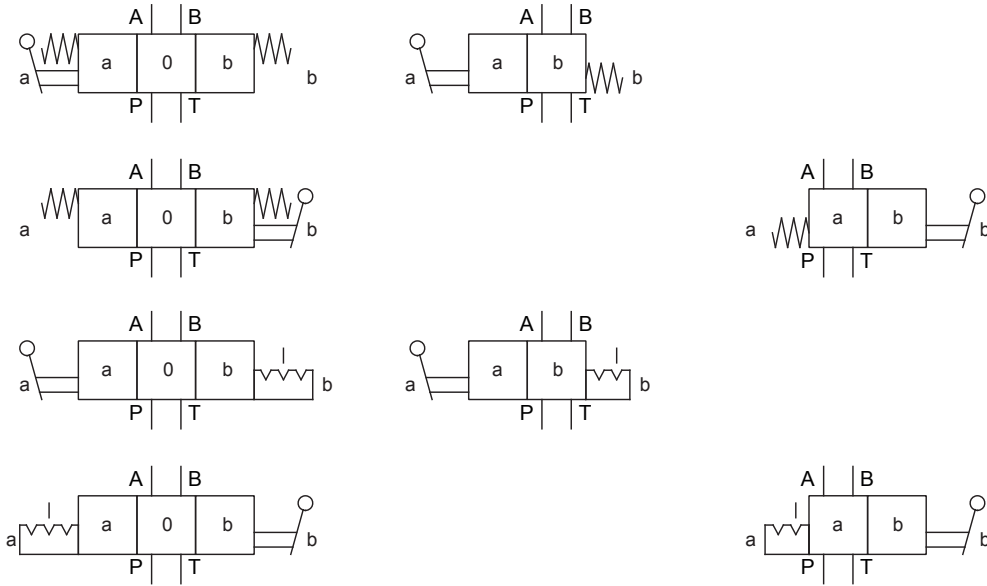

Overview spool types

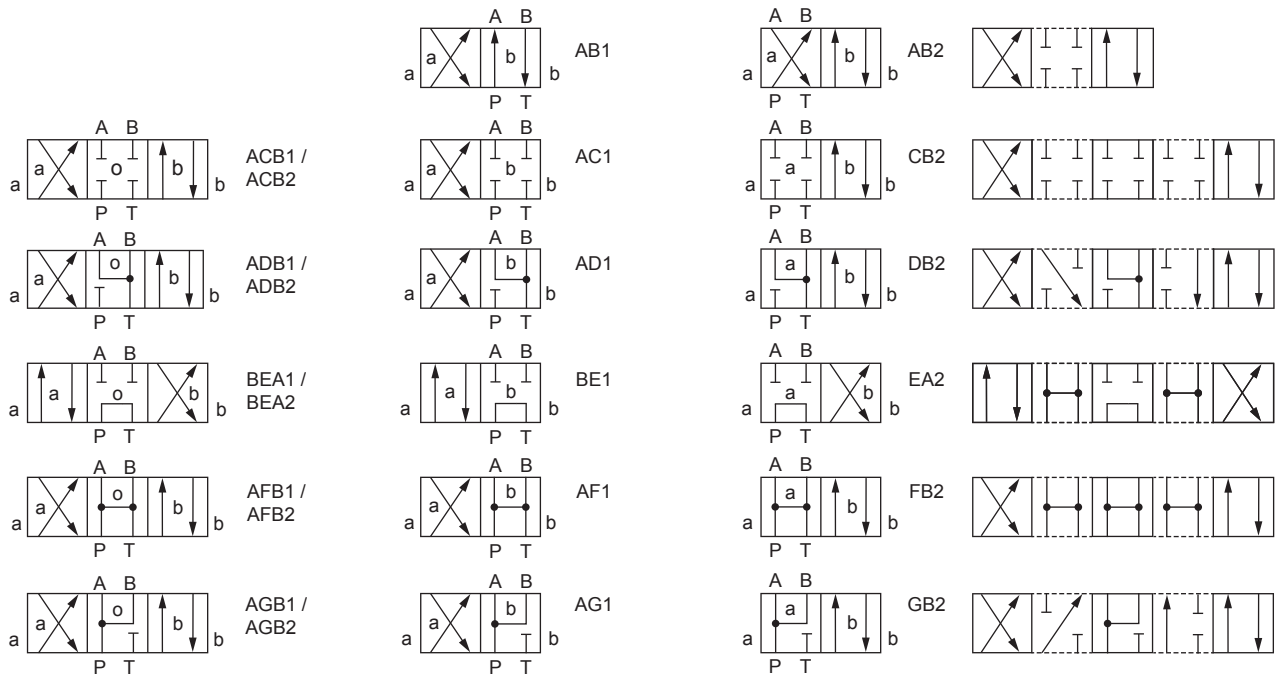

PERFORMANCE SPECIFICATIONS

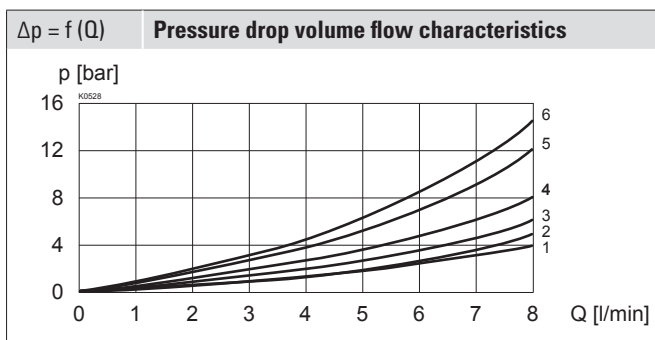
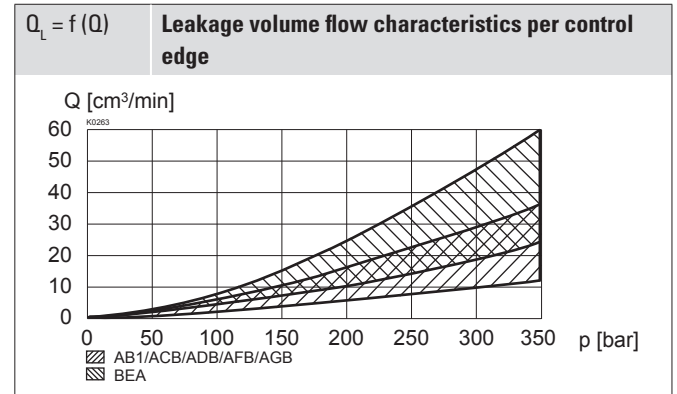
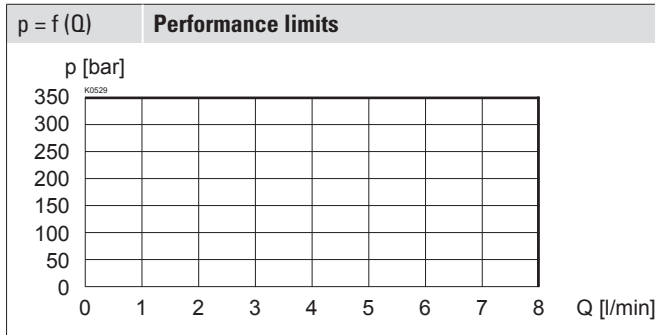
 Oil viscosity $\nu = 30 \text{ mm}^2/\text{s}$

Symbol	Volume flow direction				
	P - A	P - B	P - T	A - T	B - T
AB1 / AB2	4	4	-	3	3
ACB1 / ACB2 / AC1 / CB2	4	4	-	2	2
ADB1 / ADB2 / AD1 / DB2	3	3	-	2	2
BEA1 / BEA2 / BE1 / EA2	6	6	4	5	5
AFB1 / AFB2 / AF1 / FB2	2	2	1	2	2
AGB1 / AGB2 / AG1 / GB2	3	3	-	3	3

DIMENSIONS

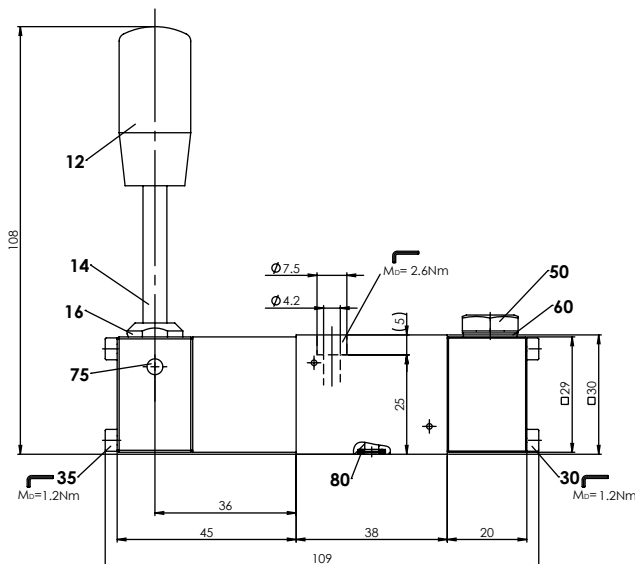

PARTS LIST

Position	Article	Description
12	081.0018	Grip
14	096.2008	Lever
16	034.1106	Bolt
30	246.0126	Socket head screw M3 x 25 DIN 912
35	246.0151	Socket head screw M3 x 50 DIN 912
50	238.1100	Screw plug M10 x 1 DIN 7604A
	239.7104	Screw plug
60	049.1080	Copper seal ring NG8 x 11.5 x 1 DIN 7603
75	221.1382	Spring tension pin $\varnothing 4 \times 24$ DIN 6325
80	160.2045	O-ring ID 4,50 x 1,50 (NBR)

Note! Screw plug 238.1100 for spring centred execution
 Screw plug 239.7104 for detented execution
 Pos. 60 only for screw plug 239.7104

ACTUATION

Actuation	Hand lever
Actuation angle	$\alpha_b = 6,7^\circ / \text{side}$
Actuation force	$F_b = 15 - 20 \text{ N}$

HYDRAULIC CONNECTION

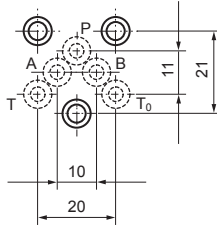

SEALING MATERIAL

NBR or FKM (Viton) as standard, choice in the type code

INSTALLATION NOTES

Mounting type	Flange mounting 3 fixing holes for socket head screws M4 x 30
Mounting position	Any, preferably horizontal
Tightening torque	$M_D = 2,6 \text{ Nm}$ (quality 8.8, zinc coated) Fixing screws

Note!



The length of the fixing screw depends on the base material of the connection element.

ACCESSORIES

Fixing screws	Data sheet 1.0-60
Threaded subplates	Data sheet 2.9-05
Multi-station subplates	Data sheet 2.9-45
Horizontal mounting blocks	Data sheet 2.9-85
Technical explanations	Data sheet 1.0-100
Hydraulic fluids	Data sheet 1.0-50
Filtration	Data sheet 1.0-50

STANDARDS

Mounting interface	Wandfluh standard
Contamination efficiency	ISO 4406

SURFACE TREATMENT

- ◆ The valve body is painted with a two component paint
- ◆ The hand lever housing, the screws and the cover are zinc coated