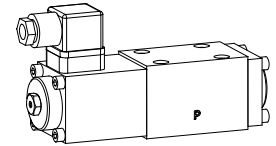

Solenoid operated spool valve

- 4/2-way impulse valve
- 4/3-way with spring centred mid position
- 4/2-way with spring reset
- $Q_{max} = 80 \text{ l/min}$, $p_{max} = 350 \text{ bar}$

NG6
 ISO 4401-03

DESCRIPTION

Direct operated solenoid valve with 4 ports in 5 chamber design. Spool detented or with spring reset. Precise spool fit, low leakage, long life time. Threaded ports through additional base plate. Spool made from hardened steel, body from high quality cast steel. Wide range of standard and special voltages. The body made of high grade hydraulic casting for long service life is painted. The solenoid and the cover are zinc coated. The socket head screws are zinc coated.

FUNCTION

- 4/2-way detented spool valve: 2 solenoids and 2 detented positions. With the solenoids deenergised the spool remains in the last switched position.
- 4/2-way spool valve: 1 solenoid and 2 spool positions, spring off-set. With the solenoid deenergised the spool returns to the offset position.
- 4/3-way spool valve: 2 solenoids and 3 spool positions, spring centered. With the solenoids deenergised the spool returns to the center position.

APPLICATION

Solenoid operated spool valves are mainly used for controlling direction of movement and stopping of hydraulic cylinders and motors. Direction of movement depends on the position of spool and its flow symbol. Please pay attention to the performance limits and leakage of the valves. Solenoid operated spool valves are suitable for machine tools and handling systems.

TYPE CODE

Spool valve, direct operated		WD	<input type="checkbox"/>	F	A06	-	<input type="checkbox"/>	-	<input type="checkbox"/>	#	<input type="checkbox"/>
Medium-solenoid	<input type="checkbox"/> M										
Super-solenoid	<input type="checkbox"/> S										
Flange construction											
International standard interface ISO, NG6											
Description of symbols acc. to table											
Nominal voltage U_N	12 VDC	<input type="checkbox"/> G12									
	24 VDC	<input type="checkbox"/> G24									
	110 VAC	<input type="checkbox"/> R110									
	115 VAC	<input type="checkbox"/> R115									
	230 VAC	<input type="checkbox"/> R230									
Design-Index (Subject to change)											

GENERAL SPECIFICATIONS

Description	4/2-, 4/3-spool valve
Nominal size	NG6 to ISO 4401/7790
Construction	Direct operated spool valve
Operations	Solenoid
Mounting	Flange 4 fixing holes for socket head screws M5 x 50
Connections	Threaded connection plates Multi-flange subplates Longitudinal stacking system
Ambient temperature	-20...+50 °C
Mounting position	any, preferably horizontal
Fastening torque	$M_D = 5,5 \text{ Nm}$ (screw quality 8.8)
Weight: 4/2-way impuls	$m = 2,4 \text{ kg}$
4/3-way	$m = 2,4 \text{ kg}$
4/2-way (1 solenoid)	$m = 1,9 \text{ kg}$

HYDRAULIC SPECIFICATIONS

Fluid	Mineral oil, other fluid on request
Contamination efficiency	ISO 4406:1999, classe 20/18/14 (Required filtration grade $\beta_{10...16} \geq 75$) refer to data sheet 1.0-50/2
Viscosity range	12 mm ² /s...320 mm ² /s
Fluid temperature	-20...+70 °C
Working pressure in port P, A, B	$p_{max} = 350 \text{ bar}$
Tank pressure in port T	Medium: $p_{max} = 160 \text{ bar}$ Super: $p_{max} = 200 \text{ bar}$
Max. volume flow	$Q_{max} = 80 \text{ l/min}$, see characteristics
Leakage volume flow	on request

ELECTRICAL CONTROL

Construction Solenoid, wet pin push type, pressure tight
 Standard-nominal voltage $U_N = 12$ VDC
 $U_N = 24$ VDC
 $U_N = 110$ VAC*
 $U_N = 115$ VAC*
 $U_N = 230$ VAC*
 AC = 50 to 60 Hz
 *Rectifier integrated in the plug,
 other nominal voltages and nominal
 performances on request.
 Voltage tolerance $\pm 10\%$ of nominal voltage
 Protection class IP 65 to EN 60529
 Relative duty factor 100% DF (see data sheet 1.1-430)
 Switching cycles 15 000/h
 Operating life 10^7 (number of switching cycles, theoretically)
 Connection/Power supply Over device plug connection to
 ISO 4400/DIN 43650, (2P+E),
 other connections on request.

SOLENOID DESCRIPTION

With respect to the selection of the solenoid, the following statements
 are important:

- The solenoid is the most expensive component of the solenoid
 spool valve.
- For this reason, it is not economical to use the same solenoid for
 all applications.
- Depending on the application, sales area, and customer,
 the requirements for solenoid spool valves and solenoids differ
 very considerably.
- In order to be able to offer the customer an optimum, we can
 supply our solenoid spool valves NG6 in 2 different versions:
 - Medium SIN45V (data sheet 1.1-120)
 - Super SIS45V (data sheet 1.1-125)

TYPE LIST / DESIGNATION OF SYMBOLS

4/2-way valve impulse

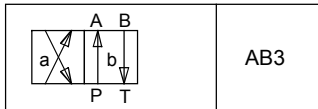
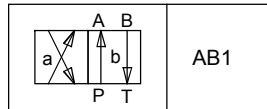
 4/2-way valve with spring reset
 operation A-side

operation B-side

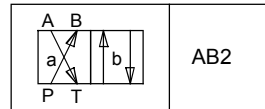

Transitional functions

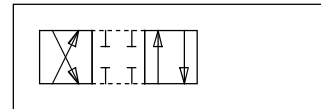

4/3-way valve spring centered

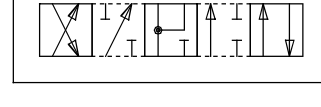
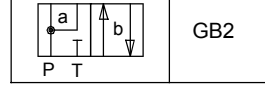
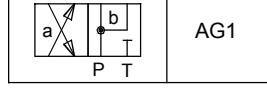
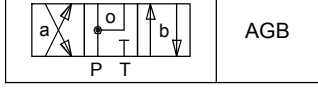
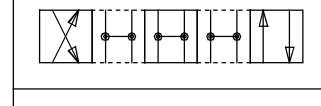
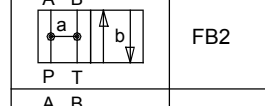
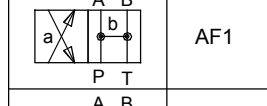
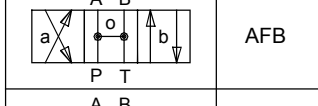
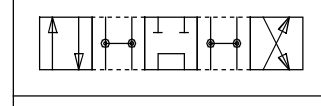
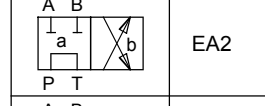
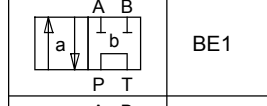
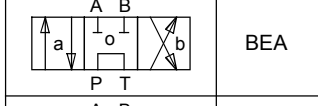
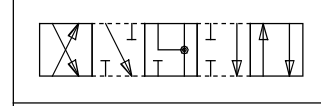
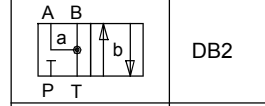
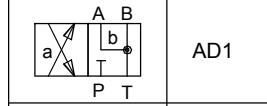
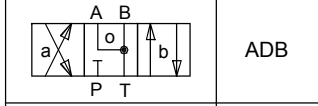
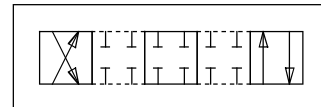
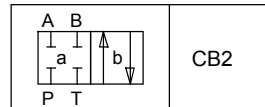
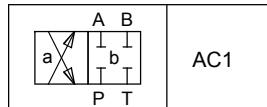
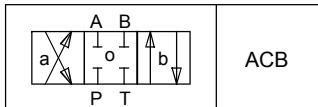

CHARACTERISTICS Oilviscosity $\nu = 30$ mm²/s

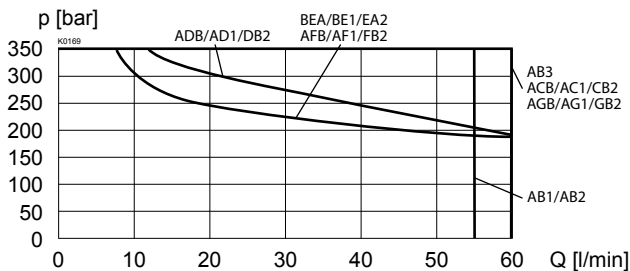
$p = f(Q)$ Performance limits
 with standard voltage -10%
 Medium

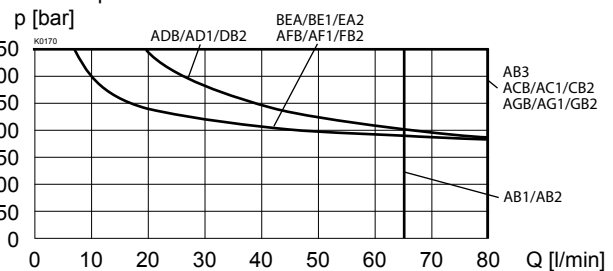

$p = f(Q)$ Performance limits
 with standard voltage -10%
 Super

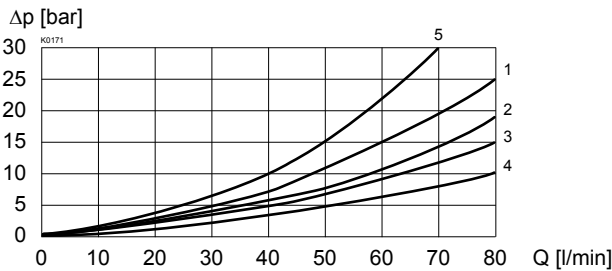

$\Delta p = f(Q)$ Pressure drop volume flow characteristics

Symbol	Pressure drop Curve no.	Volume flow direction				
		P - A	P - B	P - T	A - T	B - T
AB1/AB2/AB3	2	2	2	-	1	1
ACB/AC1/CB2	2	2	2	-	1	1
ADB/AD1/DB2	2	2	2	-	3	3
BEA/BE1/EA2	2	2	5	2	2	
AFB/AF1/FB2	4	4	-	3	3	
AGB/AG1/GB2	4	4	-	1	1	

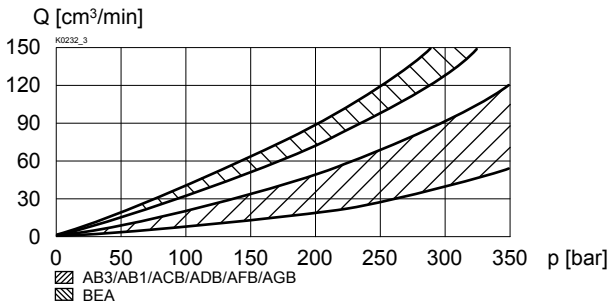
 $Q_L = f(p)$ Leakage volume flow characteristics per control edge

DIMENSIONS

4/3-way valve (spring centered)

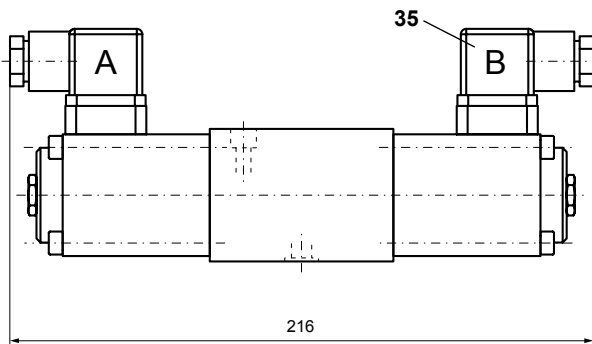
4/2-way valve (impulse)

 H = Height
 B = Wide

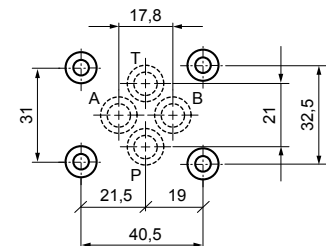
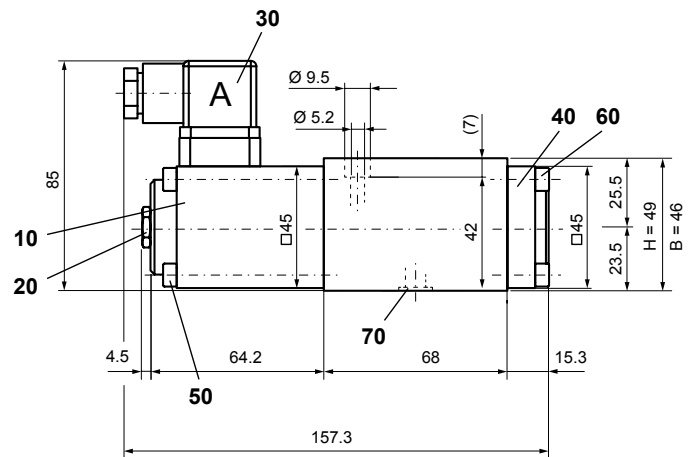
4/2-way valve (spring reset)

PARTS LIST

Position	Article	Description
10	260.6... 260.7...	Medium-solenoid SIN45V Super-solenoid SIS45V
20	253.8001	Plug with integrated manual override HB6
30	219.2001	Electric plug A (grey)
35	219.2002	Electric plug B (black)
40	058.4211	Cover
50	246.2160	Socket head screw M5x60 DIN 912
60	246.2117	Socket head screw M5x16 DIN 912
70	160.2093	O-ring ID 9,25 x1,78

ACCESSORIES

Threaded connecting plates, Multi-flange subplates and Longitudinal stacking system

see Reg. 2.9

Technical explanation see data sheet 1.0-100