

Proportional spool valve with integrated electronics

Flange construction

- ◆ direct operated
- ◆ $Q_{max} = 20 \text{ l/min}$
- ◆ $Q_{Nmax} = 12 \text{ l/min}$
- ◆ $p_{max} = 350 \text{ bar}$

DESCRIPTION

Direct operated proportional spool valve with 4 connections in 5-chamber system with integrated electronics. The Plug & Play valves are factory set and adjusted and have therefore a high valve-to-valve reproducibility. With protection class IP67 for the electronics, these valves are suitable for harsh environmental conditions. Proportional to the electronically transmitted command value, the spool stroke, the spool opening and the valve volume flow increase. The control takes place via an analogue interface or a fieldbus interface (CANopen, J1939 or Profibus DP). The parameterisation takes place by means of the free of cost parameterisation and diagnostics software «PASO» or via fieldbus interface. The USB parameterisation interface is accessible through a screw plug. As an option, these valves are available with integrated controller. As feedback value generators sensors with voltage or current output can be connected directly. The available controller structures are optimised for applications with hydraulic actuations.

NG4-Mini Wandfluh standard

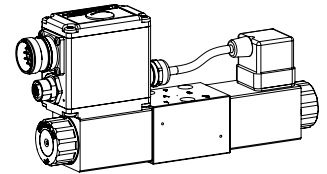

APPLICATION

Proportional spool valves are perfectly suitable for demanding tasks due to the high resolution, large volume flow and low hysteresis. The applications are in the industry as well as in the mobile hydraulics for the smooth control of hydraulic actuators. Some examples: control of the rotor blades of wind generators, forestry and earth moving machines, machine tools and paper production machines, simple position controls, robotics and fan control. Miniature valves are used where both, reduced dimensions and weight are important.

Note!



„PASO“ is a Windows program in the flow diagram style, which enables the intuitive adjustment and storing of all variable parameters. The data remain saved in case of a power failure and can also be reproduced and transferred to other DSV.

SYMBOL

Symmetrical control

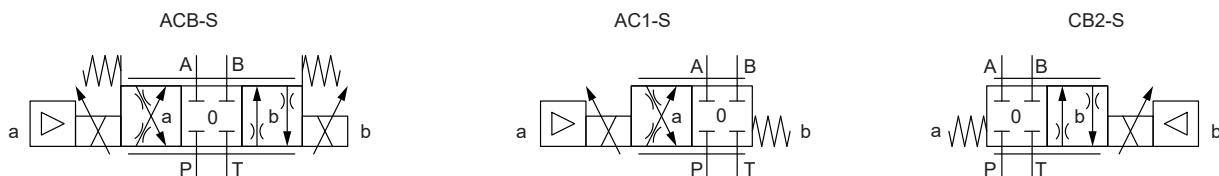

Meter-in control

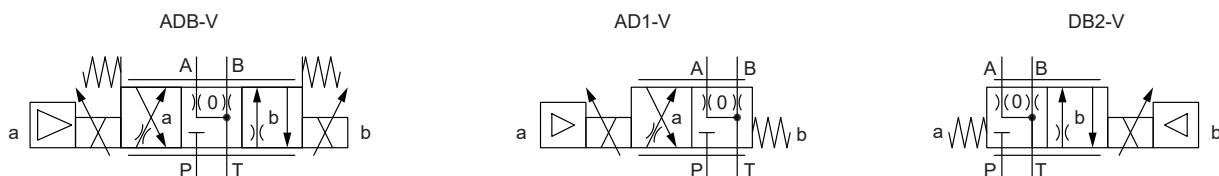

ELECTRICAL SPECIFICATIONS

Protection class	IP67 with suitable mating connector and closed housing cover
Ramps	Adjustable
Parameterisation	Via fieldbus or USB
Supply voltage	12 VDC, 24 VDC

Note!



Exact electrical specifications and detailed description of «DSV» electronics can be found on data sheet 1.13-76.

ACTUATION

Actuation	Proportional solenoid, wet pin push type, pressure tight
Connection	Via device receptacle

TYPE CODE

		W D P F A04 - <input type="checkbox"/> - <input type="checkbox"/> - <input type="checkbox"/> / N E <input type="checkbox"/> <input type="checkbox"/> - <input type="checkbox"/> <input type="checkbox"/> # <input type="checkbox"/>	
Spool valve			
Direct operated			
Proportional			
Flange construction			
Mounting interface according to Wandfluh standard, NG4-Mini			
Designation of symbols acc. to table			
Nominal volume flow rate Q_N	4 l/min <input type="checkbox"/> 4	12 l/min <input type="checkbox"/> 12	
	8 l/min <input type="checkbox"/> 8		
Nominal voltage U_N	12 VDC <input type="checkbox"/> G12		
	24 VDC <input type="checkbox"/> G24		
Slip-on coil	Metal housing square with one-sided collar		
Connection execution	Integrated electronics		
Hardware configuration			
Analog command value signal	12 pole <input type="checkbox"/> A2	7 pole <input type="checkbox"/> D2	(-10 ... 10 V preset)
Analog command value signal	12 pole <input type="checkbox"/> A4	7 pole <input type="checkbox"/> D4	(4 ... 20 mA preset)
CANopen according to DSP-408	<input type="checkbox"/> C1		
Profibus DP according to Fluid Power Technology	<input type="checkbox"/> P1		
CAN J1939 (on request)	<input type="checkbox"/> J1		
Function			
Amplifier	<input type="checkbox"/>		
Controller with current feedback value signal (0 ... 20 mA / 4 ... 20 mA)	<input type="checkbox"/> R1		
Controller with voltage feedback value signal (0 ... 10 V)	<input type="checkbox"/> R2		
Sealing material	NBR <input type="checkbox"/>		
	FKM (Viton) <input type="checkbox"/> D1		
Manual override	integrated <input type="checkbox"/>		
	Push-button <input type="checkbox"/> HF1		
	Spindle <input type="checkbox"/> HS1		
Design index (subject to change)			

1.10-3240

GENERAL SPECIFICATIONS

Designation	Proportional spool valve
Construction	Direct operated
Mounting	Flange construction
Nominal size	NG4-Mini according to Wandfluh standard
Actuation	Proportional solenoid
Ambient temperature	-20...+65 °C The upper temperature limit is a guideline for typical applications, in individual cases it may also be higher or lower. The electronics of the valve limit the power in case of a too high electronics temperature. More detailed information can be obtained from the operating instructions „DSV“.
Weight	1,8 kg
MTTFd	150 years

HYDRAULIC SPECIFICATIONS

Working pressure	$p_{max} = 350$ bar
Tank pressure	$p_{Tmax} = 160$ bar
Maximum volume flow	$Q_{max} = 20$ l/min, see characteristics
Nominal volume flow	$Q_N = 4, 8, 12$ l/min
Leakage oil	On request
Hysteresis	≤ 6 %
Fluid	Mineral oil, other fluid on request
Viscosity range	12 mm ² /s...320 mm ² /s
Temperature range fluid	-25...+70 °C (NBR) -20...+70 °C (FKM)
Contamination efficiency	Class 18 / 16 / 13
Filtration	Required filtration grade $\beta_{10...16} \geq 75$, see data sheet 1.0-50

ELECTRICAL CONNECTION

X1	Analog interface (Main)
Device receptacle	M23, 12 pole male
	1 = Supply voltage + 2 = Supply voltage 0 VDC 3 = Stabilised output voltage 4 = Command value signal voltage + 5 = Command value signal voltage - 6 = Command value signal current + 7 = Command value signal current - 8 = Reserved for extensions 9 = Reserved for extensions 10 = Enable signal (Digital input) 11 = Error signal (Digital output) 12 = Chassis
Command value signal voltage (PIN 4/5) resp. current (PIN 6/7) are selected with parameterisation and diagnostics software PASO.	

X1	Fieldbus interface (Main)
Device receptacle	M12, 4 pole male
	1 = Supply voltage + 2 = Reserved for extensions 3 = Supply voltage 0 VDC 4 = Chassis

X2	Parameterisation interface
USB, Mini B	Under the screw plug of the housing cover Factory set

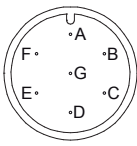
X1	Analog interface (Main)
Device receptacle	Connector DIN EN 175201 - 804
	7 pole male A = Supply voltage + B = Supply voltage 0 VDC C = Not connected D = Command value signal + E = Command value signal - F = Not connected G = Chassis
Command value signal: current (D4) or voltage (D2) to specify when placing the order	

X3	Profibus interface according to IEC 947-5-2
Device receptacle	M12, 5 pole female B-coded
	1 = VP 2 = RxD / TxD - N 3 = DGND 4 = RxD / TxD - P 5 = Shield

X3	CANopen interface according to DRP 303-1
Device receptacle	M12, 5 pole male
	1 = Not connected 2 = Not connected 3 = CAN Gnd 4 = CAN High 5 = CAN Low

X4 (controller only)	Feedback value interface (sensor)
Device receptacle	M12, 5 pole female
	1 = Supply voltage (output) + 2 = Feedback value signal + 3 = Supply voltage 0 VDC 4 = Not connected 5 = Stabilised output voltage
Feedback value signal: current (R1) or voltage (R2) to specify when placing the order	

Note! The mating connector is not included in the delivery

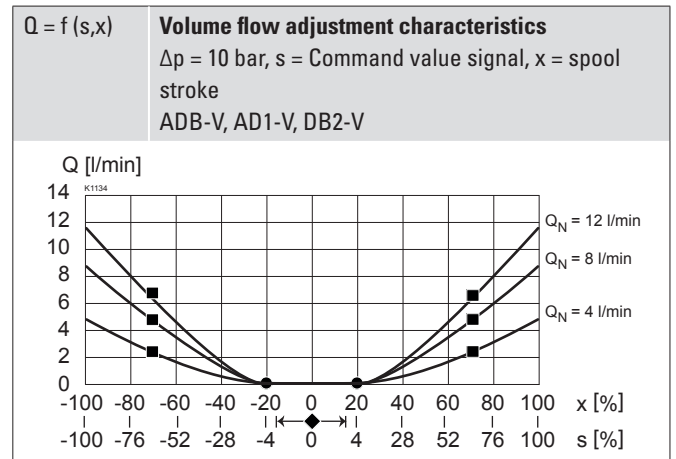
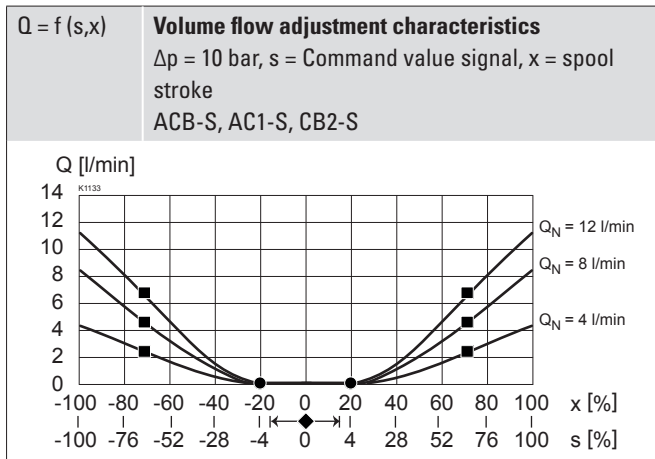
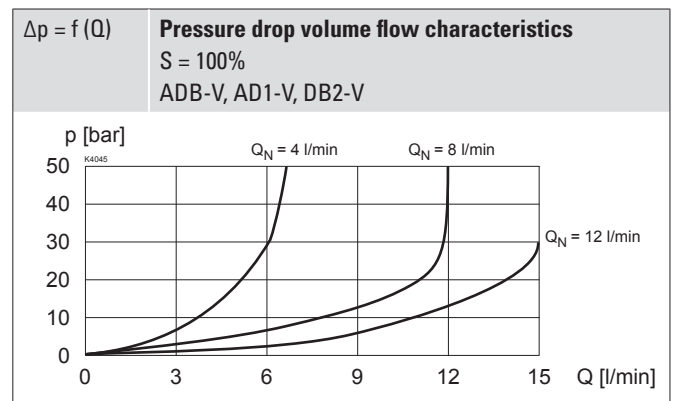
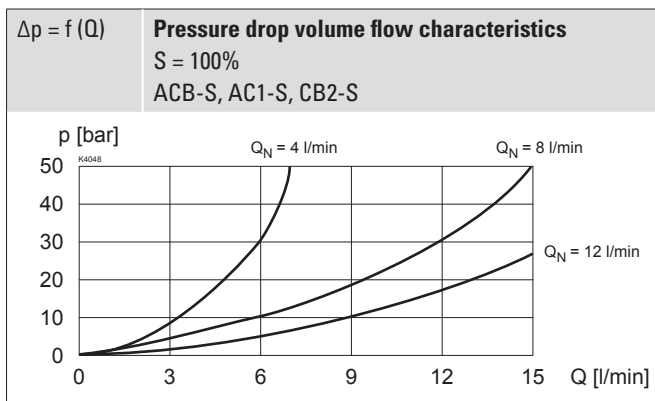
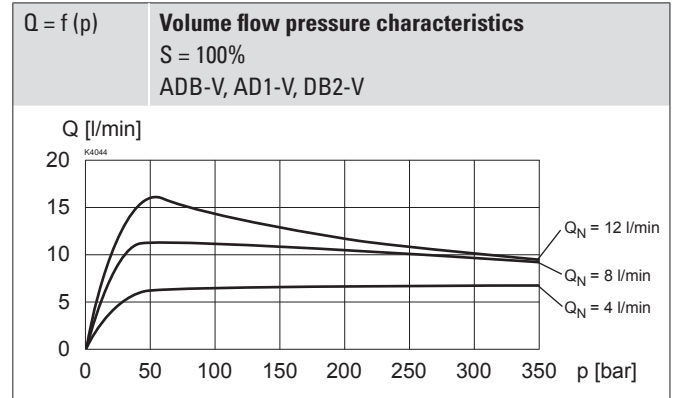
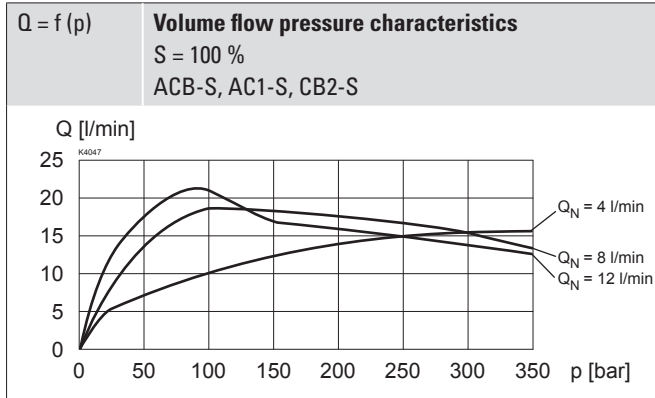

PERFORMANCE SPECIFICATIONS

 Oil viscosity $\nu = 30 \text{ mm}^2/\text{s}$

Note!

All values were measured over two control edges. The connections A and B were short-circuited.

FACTORY SETTINGS

Dither set for optimum hysteresis

- ◆ = Deadband: Both solenoids switched off at command value signal -2%... 2%
- = Opening pressure at command value signal + / - 4%
- = Flow at $\Delta p = 10 \text{ bar}$ over two control edges + / - 70% command value signal

DIMENSIONS

With analog interface, 12 pole connector

Amplifier and controller

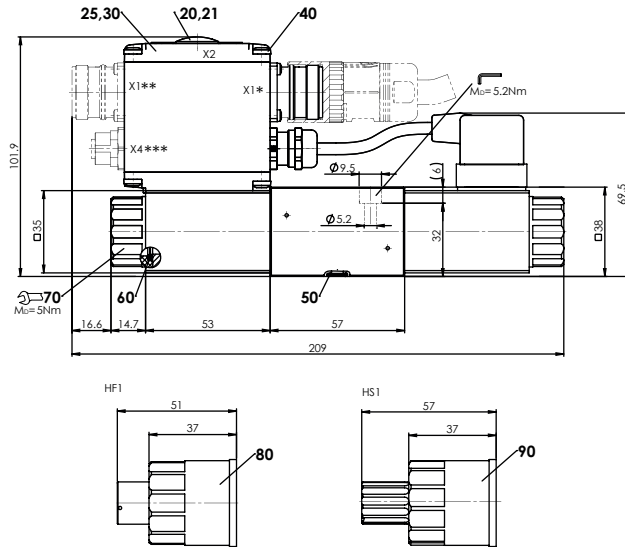

With analog interface, 7 pole connector

Amplifier and controller

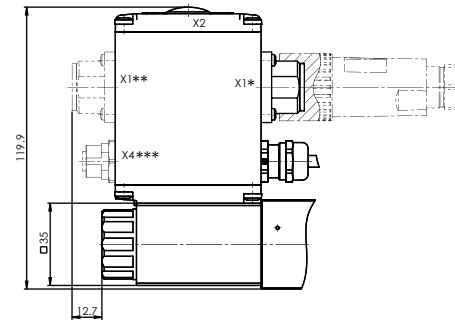

* For amplifier

** For controller

*** Only controller

With fieldbus interface

Amplifier

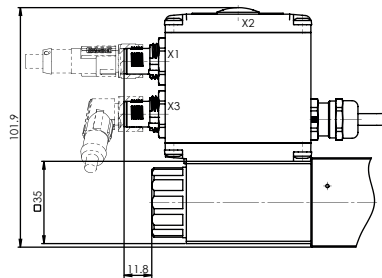

With fieldbus interface

Controller

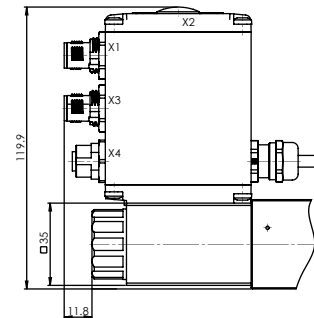

PARTS LIST

Position	Article	Description
20	223.1317	Dummy plug M16 x 1,5
21	160.6131	O-ring ID 13,00 x 1,5 (FKM)
25	062.0102	Cover
30	072.0021	Gasket 33,2 x 59,9 x 2
40	208.0100	Socket head screw M4 x 10
50	160.2052	O-ring ID 5,28 x 1,78 (NBR)
	160.6052	O-ring ID 5,28 x 1,78 (FKM)
60	160.2187	O-ring ID 18,72 x 2,62 (NBR)
70	154.2700	Knurled nut
80	253.7004	Push-button
90	253.7002	Spindle

HYDRAULIC CONNECTION

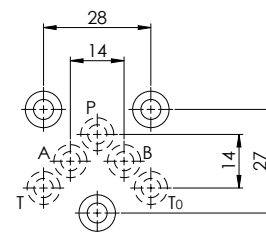

COMMISSIONING

For DSV amplifiers as a rule no parameter adjustments by the customer are required. The plugs have to be connected in accordance with the chapter «Electrical connection».

Controllers are supplied configured as amplifiers. The adjustment of the mode of control and of the controller are carried out by the customer by means of the software adjustment (USB interface, Mini B).

Further information can be found on: «www.wandfluh.com».

Free- of charge download of the «PASO» software and the operation instructions for «DSV» hydraulic valves as well as the operation instructions CANopen Protocol resp. Profibus DP Protocol, with Device Profile DSP-408 for «DSV».

Note!



The mating connectors and the parameterisation cable are not part of the delivery. Refer to chapter «Accessories».

SEALING MATERIAL

NBR or FKM (Viton) as standard, choice in the type code

SURFACE TREATMENT

Standard:

-The valve body, the armature tube, the slip-on coil and the plug screw are zinc-nickel coated

ISO 9227 (800 h) salt spray test

INSTALLATION NOTES

Mounting type	Flange mounting 3 fixing holes for socket head screws M5 x 40
Mounting position	Any, preferably horizontal
Tightening torque	Fixing screws $M_0 = 5,2 \text{ Nm}$ (screw quality 8.8, zinc coated) $M_0 = 5 \text{ Nm}$ knurled nut

Note!



The length of the fixing screw depends on the base material of the connection element.

ACCESSORIES

Parameterisation software	See start-up
Parameterisation cable for interface USB (from plug type A on Mini B, 3 m)	Article no. 219.2896
Mating connector (plug female) for analog interface	
straight, soldering contact M23, 12 pole	Article no. 219.2330
angled, soldering contact M23, 12 pole	Article no. 219.2331
straight, soldering contact, 7 pole	Article no. 219.2335
Threaded subplates	Data sheet 2.9-10
Multi-station subplates	Data sheet 2.9-50
Module type manifold blocks	Data sheet 2.9-90
Technical explanations	Data sheet 1.0-100
Filtration	Data sheet 1.0-50
Relative duty factor	Data sheet 1.1-430

Note!



Auxiliary conditions for the cable:
 – External diameter 12 pol: 3,5...14,7 mm
 – External diameter 7 pol: 8...10 mm
 – Wire cross section max. 1 mm²
 – Recommended wire cross section:
 0...25 m = 0,75 mm² (AWG18)
 25...50 m = 1 mm² (AWG17)

STANDARDS

CANopen	DRP 303-1
Profibus DP	IEC 947-5-2
Mounting interface	Wandfluh standard
Protection class	EN 60 529
Contamination efficiency	ISO 4406

MANUAL OVERRIDE

- ◆ Integrated (–) Actuation pin integrated in the armature tube. Actuation by pressing the pin
- ◆ Push-button (HF1) Integrated in the knurled nut. Actuation by pressing the push-button
- ◆ Spindle (HS1) Integrated in the knurled nut. Actuation by turning the spindle (continuously variable valve actuation)

Attention!



The actuation of the manual override is possible up to a tank pressure of:
 160 bar Integrated (–)
 160 bar Push-button (HF1)
 160 bar Spindle (HS1)