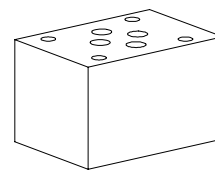

**Non-return valve  
Sandwich construction**

- $Q_{max} = 80 \text{ l/min}$
- $p_{max} = 350 \text{ bar}$

**NG6**  
 ISO 4401-03

**DESCRIPTION**

Sandwich type pilot operated non-return valve NG6 with interface according to ISO 4401-03. The valves allow a free flow in one direction and shut off in the opposite direction. 6 different standard versions are available. The steel sandwich body is phosphatised. Good performance data and attractive design are the hall marks of this quality product.

**FUNCTION**

In the free flow direction, the volume flow opens the spring loaded valve seat. The spring keeps the valve closed in the opposite direction. The opening pressure required depends on the spring force.

**APPLICATION**

Non-return valves allow the volume flow in one direction and shuts off in the opposite direction, preventing the pressurised fluid from flowing back. Non-return valves in the P port prevents backward rotation of the pump. When installed in the T port, the spring controlled opening pressure prevents a hydraulic system from draining to the tank. Sandwich type elements NG6 make this a highly flexible system.

**CONTENT**

GENERAL SPECIFICATIONS .....	1
HYDRAULIC SPECIFICATIONS .....	1
SYMBOLS / TYPES .....	1
CHARACTERISTICS .....	2
DIMENSIONS .....	2
PARTS LIST .....	2

**TYPE CODE**

Non-return valve in sandwich construction	RNNS	A06	-	<input type="text"/>	#	<input type="text"/>
International mounting interface ISO, NG6						
Non-return valve in:						
P <input type="checkbox"/> T <input type="checkbox"/> P and T <input type="checkbox"/>	<input type="checkbox"/>	<input type="checkbox"/>	<input type="checkbox"/>			
A <input type="checkbox"/> B <input type="checkbox"/> A and B <input type="checkbox"/>	<input type="checkbox"/>	<input type="checkbox"/>	<input type="checkbox"/>			
Design-Index (Subject to change)						

**GENERAL SPECIFICATIONS**

Description	Non-return valve
Nominal size	NG6 acc. to ISO 4401-03
Construction	Sandwich construction
Mounting	4 holes for hexagon socket screw M5 or studs M5
Connections	Connection plates Multi-station flange subplate Longitudinal stacking system
Ambient temperature	-20...+50°C
Mounting position	any
Fastening torque	$M_D = 5,5 \text{ Nm}$ (Quality 8.8)
Weight	$m = 0,85 \text{ kg}$

**HYDRAULIC SPECIFICATIONS**

Fluid	Mineral oil, other fluid on request
Contamination efficiency	ISO 4406:1999, class 20/18/14 (Required filtration grade $\beta_{10...16} \geq 75$ ) refer to data sheet 1.0-50/2
Viscosity range	12 mm <sup>2</sup> /s...320 mm <sup>2</sup> /s
Fluid temperature	-20...+70°C
Peak pressure	$p_{max} = 350 \text{ bar}$
Opening pressure	$p_o = 2 \text{ bar}$
Max. volume flow	$Q_{max} = 80 \text{ l/min}$

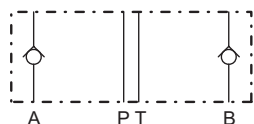
**SYMBOLS / TYPES**

RNNSA06-AB

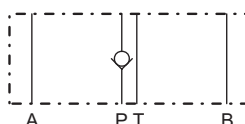

RNNSA06-P

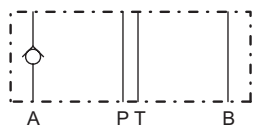

RNNSA06-A

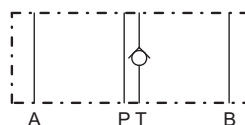

RNNSA06-T



RNNSA06-B

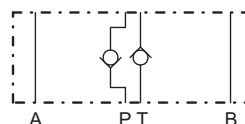

RNNSA06-PT

**CHARACTERISTICS** Oil viscosity  $\nu = 30 \text{ mm}^2/\text{s}$

$\Delta p = f(Q)$  Performance limit

$\Delta p$  [bar]

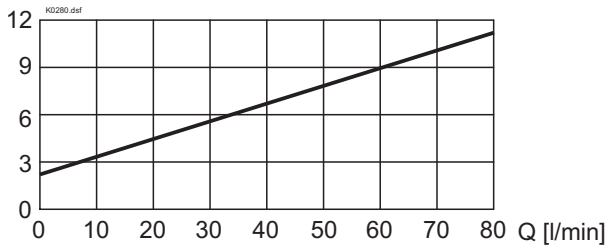

**DIMENSIONS**

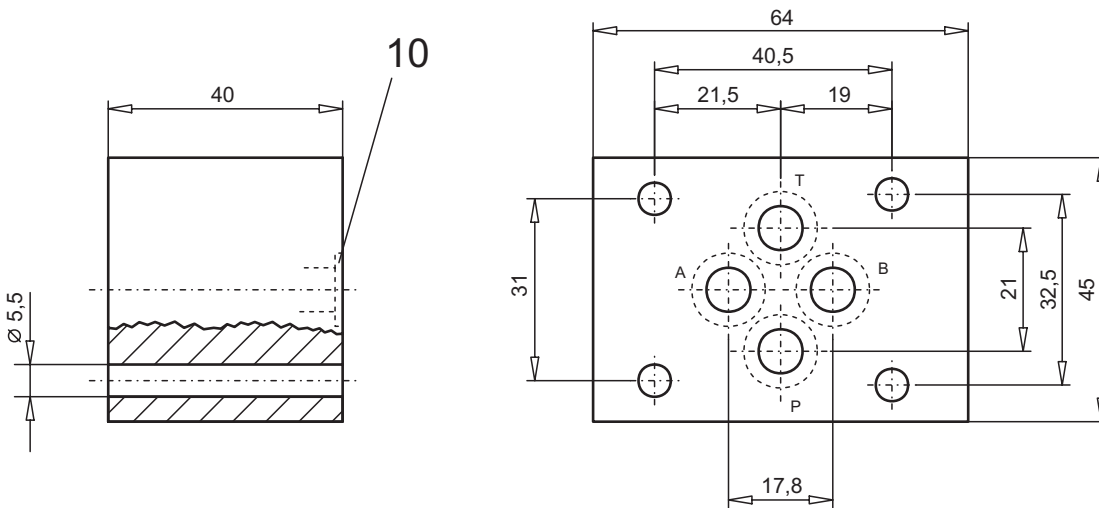

**PARTS LIST**

Position	Article	Description
10	160.2093	O-ring ID 9,25x1,78

Technical explanation see data sheet 1.0-100E