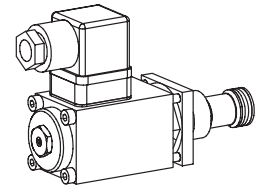

**Proportional pressure relief valve
Screw-in cartridge**

- Direct operated
- $Q_{max} = 25 \text{ l/min}$
- $p_{max} = 400 \text{ bar}$
- $p_{Nmax} = 350 \text{ bar}$

M22x1,5
 ISO 7789

DESCRIPTION

Direct operated proportional pressure relief valve as a screw-in cartridge with a thread M22x1,5 for cavity according to ISO 7789. Four standard pressure ranges are available: 20, 100, 200, 315 and 350 bar. Good flow performance thanks to the differential area principle. Small leak along the poppet guide. Adjusted by a Wandfluh proportional solenoid (VDE standard 0580). The cartridge and the solenoid made of steel are zinc coated and therefore rust-protected.

FUNCTION

The valve limits the pressure in port P (1) and relieves the volume flow to tank port T (2). The back pressure in T (2) influences the pressure in P (1). When the operating pressure set by the proportional solenoid is reached, the poppet spool opens and connects the protected line to the tank T (2). These pressure relief valves are built according to the differential spool principle and are therefore very sensitive adjustable over the whole pressure range and also suitable for systems with extremely low minimum pressures. Wandfluh proportional amplifiers are available to control the proportional pressure relief valve (register 1.13).

APPLICATION

The valve has its application in hydraulic systems, in which the pressure frequently has to be changed. The facility for remote control and signal processing from process control systems enable elegant, comfortable solutions to problems. Installation of the screw-in cartridge in control blocks as well as in the Wandfluh sandwich plates (vertical stacked systems) and flange valves of the NG4-Mini and NG6 types. (Please note the separate data sheets in register 2.3). Cavity tools are available for machining the cavities in steel and aluminium (hire or purchase). Please refer to the data sheets in register 2.13.

CONTENT

GENERAL SPECIFICATIONS	1
HYDRAULIC SPECIFICATIONS	1
ELECTRICAL SPECIFICATIONS	1
SYMBOL.....	1
CHARACTERISTICS.....	2
DIMENSIONS/ SECTIONAL DRAWINGS.....	2
PARTS LIST	2
ACCESSORIES.....	2

TYPE CODE

Pressure relief valve	B	D	P	PM22	-	[]	-	[]	#	[]
Direct operated										
Proportional										
Screw-in cartridge M22x1,5										
Standard nominal pressure range:	$p_N = 20 \text{ bar}$	[20]								
	$p_N = 100 \text{ bar}$	[100]								
	$p_N = 200 \text{ bar}$	[200]								
	$p_N = 315 \text{ bar}$	[315]								
	$p_N = 350 \text{ bar}$	[350]								
Standard nominal voltage:	$U_N = 12 \text{ VDC}$	[G12]								
	$U_N = 24 \text{ VDC}$	[G24]								
Design-Index (Subject to change)										

• Data sheet is valid from design-index # 2 on

GENERAL SPECIFICATIONS

Description	Direct operated proportional pressure relief valve
Construction	Screw-in cartridge for cavity to ISO 7789
Operations	Proportional solenoid
Mounting	Screw-in thread M22x1,5
Ambient temperature	-20...50 °C
Mounting position	any
Fastening torque	$M_D = 50 \text{ Nm}$ for screw-in cartridge $M_D = 2,6 \text{ Nm}$ (qual. 8.8) for solenoid screws
Weight	$m = 0,6 \text{ kg}$

HYDRAULIC SPECIFICATIONS

Fluid	Mineral oil, other fluid on request
Contamination efficiency	ISO 4406:1999, class 18/16/13 (Required filtration grade $\beta_{6...10} \geq 75$) see data sheet 1.0-50/2
Viscosity range	12 mm ² /s...320 mm ² /s
Fluid temperature	-20...+70 °C
Peak pressure	$p_{max} = 400 \text{ bar}$
Nominal pressure ranges	$p_N = 20 \text{ bar}, p_N = 100 \text{ bar},$ $p_N = 200 \text{ bar}, p_N = 315 \text{ bar}$
Min. volume flow	$Q_{min} = 0,1 \text{ l/min}$
Max. volume flow	$Q_{max} = 25 \text{ l/min}$ for $p_N = 20/100/200 \text{ bar}$ $Q_{max} = 20 \text{ l/min}$ for $p_N = 315 \text{ bar}$ $Q_{max} = 2 \text{ l/min}$ for $p_N = 350 \text{ bar}$ see characteristics
Leakage volume flow	see characteristics
Repeatability	$\leq 1,5 \% *$
Hysteresis	$\leq 3 \% *$ * at optimal dither signal

ELECTRICAL SPECIFICATIONS

Construction	Proportional solenoid, wet pin push type, pressure tight.	
Standard-Nominal voltage	$U_N = 12 \text{ VDC}$	$U_N = 24 \text{ VDC}$
Limiting current	$I_G = 1250 \text{ mA}$	$I_G = 680 \text{ mA}$
Relative duty factor	100% DF (see data sheet 1.1-430)	
Protection class	IP 65 acc. to EN 60 529	
Connection/Power supply	Over device plug connection to ISO 4400 / DIN 43 650 (2P+E)	
Other electrical specifications	see data sheet 1.1-115 (PI35PV)	

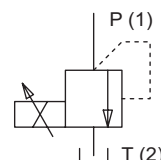
SYMBOL

CHARACTERISTICS oil viscosity $\nu = 30 \text{ mm}^2/\text{s}$

$p = f(Q)$ Pressure volume flow characteristics
(Maximum adjustable pressure)

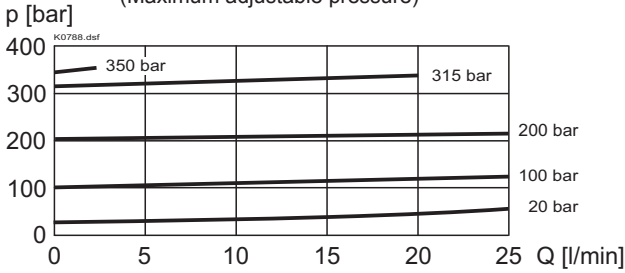

$p = f(Q)$ Pressure volume flow characteristics
(Minimum adjustable pressure)

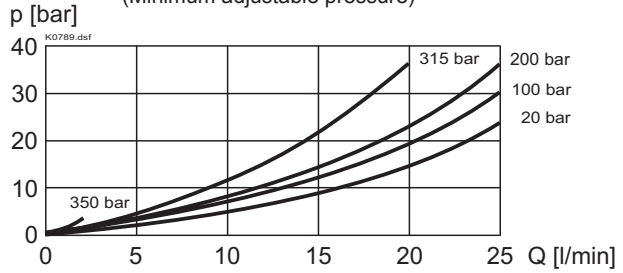

$p = f(I)$ Pressure adjustment characteristics
($Q = 1 \text{ l/min}$)

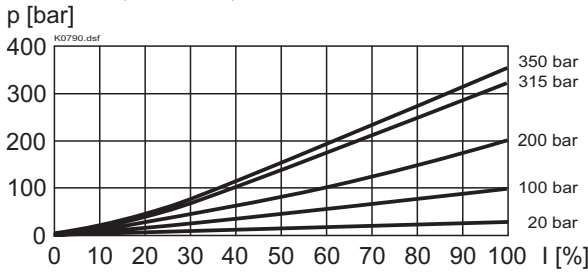

$Q_L = f(p)$ Leakage volume flow characteristics

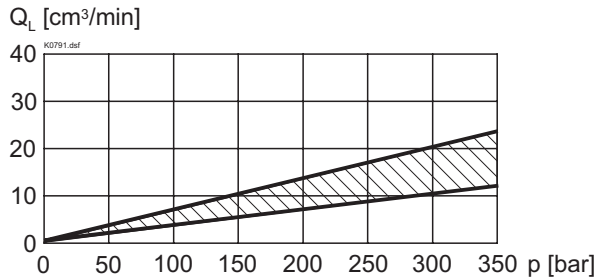

DIMENSIONS / SECTIONAL DRAWINGS

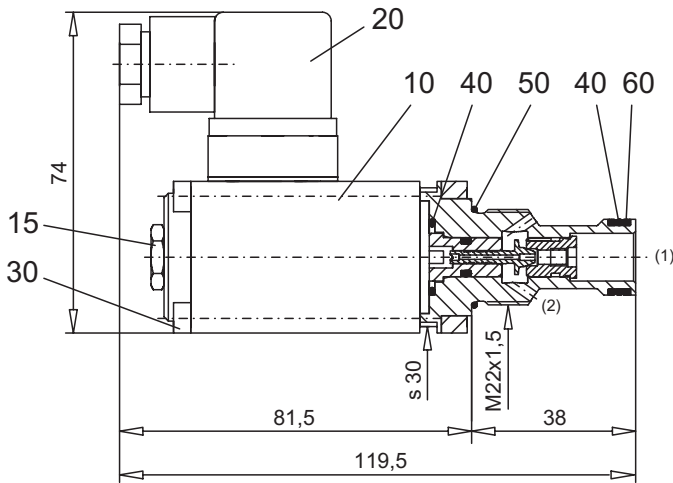

Cavity drawing according to
ISO 7789-22-02-0-98

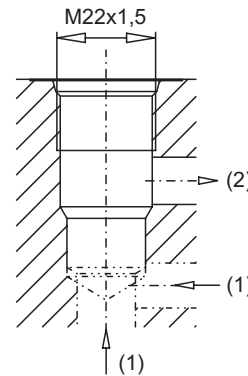

For detailed cavity drawing
and cavity tools see data
sheet 2.13-1003

PARTS LIST

Position	Article	Description
10	256.3555 256.3414	Proportional solenoid PI35PV-G24 Proportional solenoid PI35PV-G12
15	253.8000	Mounted screw with integrated manual override HB4,5
20	219.2002	Plug (black)
30	249.1007	Socket head cap screw M4x63
40	160.2140	O-ring ID 14,00x1,78
50	160.2188	O-ring ID 18,77x1,78
60	049.3177	Back up ring RD 14,6x17,5x1,4

ACCESSORIES

Cartridge built-in flange- or sandwich body	
Flange-/sandwich plate	Register 2.3
Proportional amplifier	Register 1.13

Technical explanation see data sheet 1.0-100