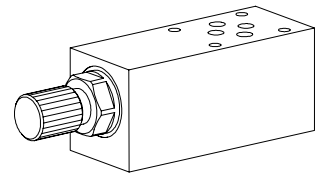

**Pressure sequence valve
Sandwich construction**

- Pilot operated
- $Q_{max} = 60$ l/min
- $p_{max} = 400$ bar
- $p_{Nmax} = 350$ bar

NG6
 ISO 4401-03

DESCRIPTION

Pressure sequence valve in sandwich construction. Connection diagram in accordance with ISO 4401-03. The valves are available in three types of adjustment, one of them being lockable, the others being fixed. A cover is also available for key adjustment, see data sheet 2.0-50. Three pressure stages are available as standard. The steel bodies of the sandwich are phosphate coated.

FUNCTION

The pressure sequence valve connects consumers in hydraulic circuits. When the set pressure has been reached, the pilot operation opens to the tank, thereby opening the main spool to the next consumer. The pilot oil flows via an internal drain line to T port. With sandwiches in A and B, return flow passes through a by-pass check valve.

APPLICATION

For sequence control of operating sequences, whereby a consumer is switched on when a specific pressure is reached. Sandwich vertical stacking valves are suitable for machine tools, also for mobile equipment of all kinds.

CONTENT

GENERAL CHARACTERISTICS	1
HYDRAULIC CHARACTERISTICS	1
CHARACTERISTICS	2
TYPE LIST	2
DIMENSIONS	2
PARTS LIST	2

TYPE CODE

	F	V	<input type="checkbox"/>	S	A06	<input type="checkbox"/>	-	<input type="text"/>	#	<input type="checkbox"/>
Pressure sequence valve										
Pilot operated										
Setting versions:	Key	<input type="checkbox"/>	S							
	Control knob	<input type="checkbox"/>	D							
	Lock	<input type="checkbox"/>	K							
	Cover	<input type="checkbox"/>	A							
Sandwich construction										
Mounting interface NG6										
Design in:	P	<input type="checkbox"/>	P							
	A	<input type="checkbox"/>	A							
	B	<input type="checkbox"/>	B							
Nominal pressure:	$p_N = 63$ bar	<input type="checkbox"/>	63							
	$p_N = 160$ bar	<input type="checkbox"/>	160							
	$p_N = 350$ bar	<input type="checkbox"/>	350							
Design-Index (Subject to change)										

GENERAL SPECIFICATIONS

Norminal Size	NG6 according to ISO 4401-03
Designation	Pressure sequence valve pilot operated
Construction	Sandwich construction
Type of fixture	4 mounting holes for M5 socket head screws or M5 locking screws.
Tightening torques	$M_D = 5,5$ Nm (qual. 8.8) for fixing screws $M_O = 50$ Nm for screw cartridges
Type of connections	Thread- connection plates Rows of flange plates and horizontal stacking system.
Installation position	any
Ambient temperature	-20...+50°C
Weight	m = 1,4 kg

HYDRAULIC SPECIFICATIONS

Hydraulic fluid	Mineral oils, other media on request
Max. permissible contamination level	ISO 4406:1999, class 18/16/13 (Recommended filter gauge $\beta_{6...10} \geq 75$) see data sheet 1.0-50/2
Viscosity range	12 mm ² /s...320 mm ² /s
Hydraulic fluid temp.	-20...+70°C
Peak pressure	$p_{max} = 400$ bar
Rated pressure ranges	$p_N = 63$ bar, 160 bar, 350 bar
Minimum pressure	see curve
Opening pressure over non-return valve	$p_o = 2,0$ bar
Maximum volume flow	$Q_{max} = 60$ l/min

Other hydraulic characteristics can be obtained from the data sheets 2.1-546 for cartridge M22x1,5.

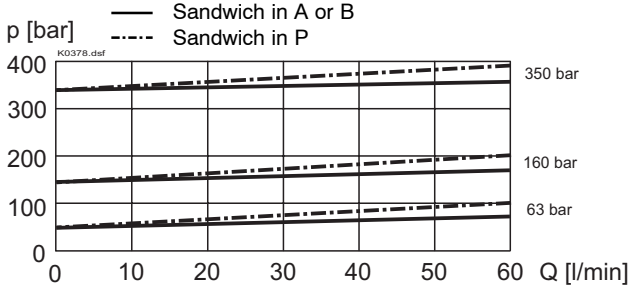
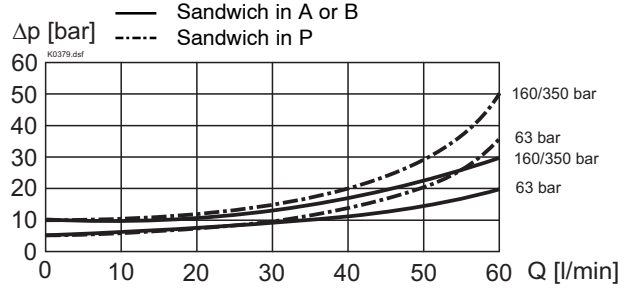
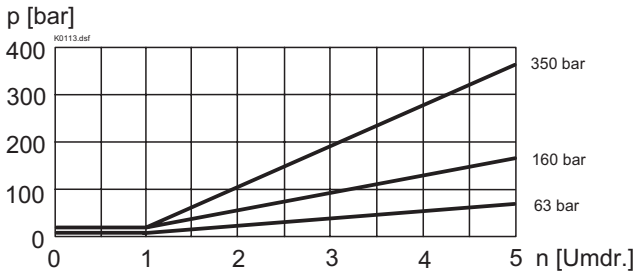
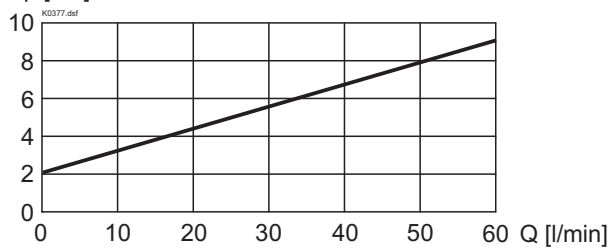
CHARACTERISTICS oil viscosity $\nu = 30\text{mm}^2/\text{s}$
 $p = f(Q)$ Pressure volume flow charac. (max.adjustable pressure)

 $p = f(Q)$ Pressure volume flow charac. (min.adjustable pressure)

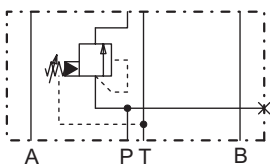
 $p = f(n)$ Pressure adjustment characteristics

 $\Delta p = f(Q)$ Pressure-drop flow characteristics curve over non-return valve

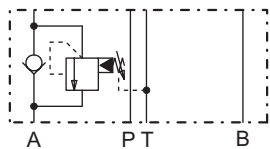
TYPE LIST / DIMENSIONS

FV.SA06-P



FV.SA06-A

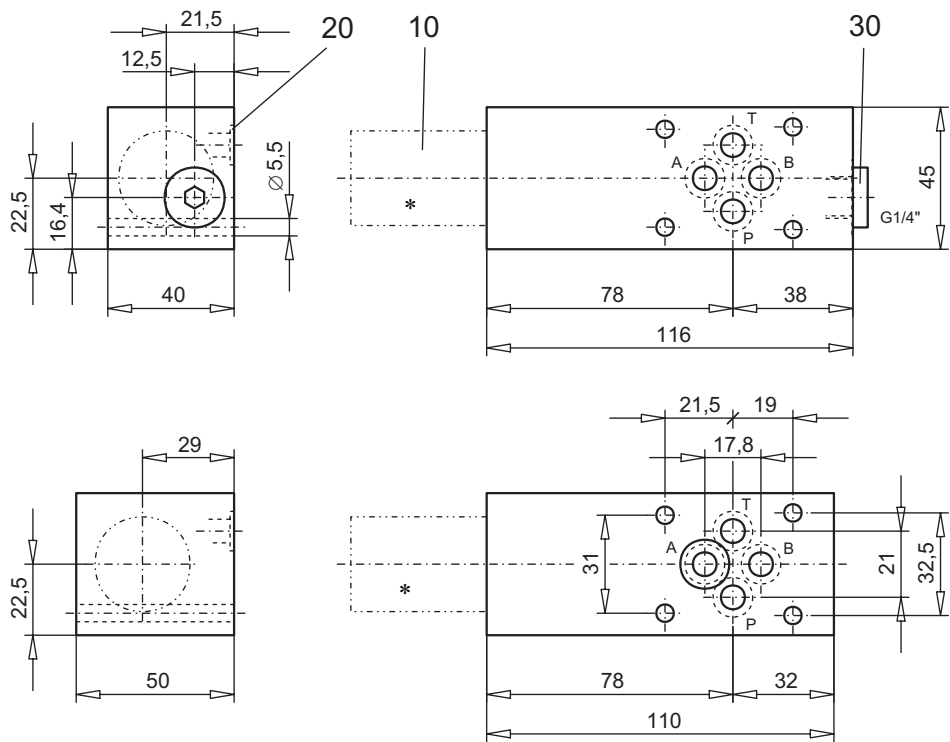
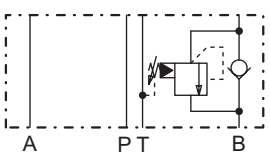

FV.SA06-B

PARTS LIST

Position	Article	Description
10	593.	Pressure sequence cartridge M22x1,5 to data sheet 2.1-546
20	160.2093	O-ring ID 9,25x1,78
30	238.2406	Plug VSTI G1/4"-ED

On sandwich type B cartridge is located on B-Side.

* The exterior dimensions or the cartridges can be obtained from the data sheet 2.1-546.

Technical explanation see data sheet 1.0-100E