

Proportional spool valve

Flange construction

- ◆ $Q_{max} = 35 \text{ l/min}$
- ◆ 4 volume flow levels
- ◆ $Q_{Nmax} = 25 \text{ l/min}$
- ◆ $p_{max} = 350 \text{ bar}$

NG6

ISO 4401-03

- Ex db IIC T6, T4 Gb (Zone 1)
- Ex tb III C T80 °C, T130 °C Db (Zone 21)
- Ex db I Mb
- ⊕ II 2 G Ex db IIC T6, T4
- ⊕ II 2 D Ex tb III C T80 °C, T130 °C
- ⊕ I M2 Ex db I Mb
- Class I, Division 1, Group A, B, C, D T4
- Class II & III, Division I, Group E, F, G T4

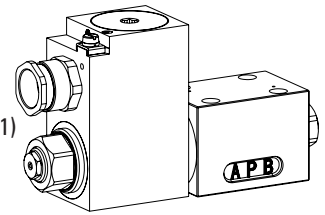

DESCRIPTION

Direct operated proportional spool valve with 4 connections in 5-chamber system. Precise spool fit, low leakage, long service life time. Proportional to the solenoid current, the spool stroke, the spool opening and the valve volume flow increase. The pressure tight encapsulated Ex-protection solenoid coil prevents an explosion on the inside penetrating to the outside as well as an ignitable surface temperature.

APPLICATION

These valves are suitable for applications in explosion-hazard areas, open cast and also in mines. Proportional spool valves are perfectly suitable for demanding tasks due to the high resolution, large volume flow and low hysteresis. The applications are in the industrial as well as in the mobile hydraulics for the smooth control of hydraulic actuations.

CERTIFICATES

	Surface	Mining	Standard -25 °C to...	M248 Electronic
ATEX / UKEX	x	x	x	x
IECEX	x	x	x	x
CCC	x	x	x	x
EAC	x	x	x	x
Australia	x	x	x	
MA		x	x	x
USA / Canada	x		x	x
PESO	x		x	x

The certificates can be found on www.wandfluh.com

ACTUATION

Actuation	Proportional solenoid, wet pin push type, pressure tight
Execution	MKY45 / 18x60 (Data sheet 1.1-183)
Connection	Cable gland for cable Ø 6,5...14 mm

Attention! The UC execution is always supplied without cable gland



SYMBOL

Symmetrical control

ACB-S

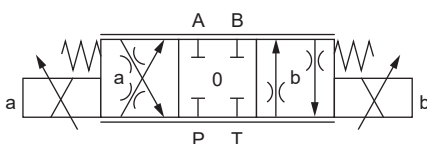

AC1-S

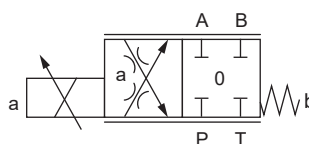

CB2-S

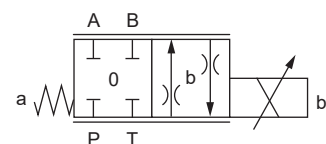

Meter-in control

ADB-V

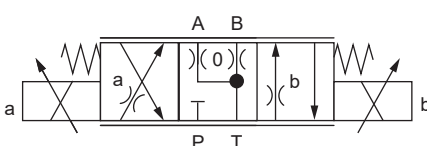

AD1-V

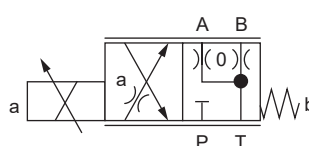

DB2-V

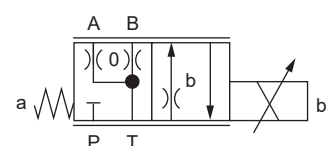

TYPE CODE

WD B F A06 - - - / / - # 1

Spool valve, direct operated
 Proportional, explosion proof execution Ex d
 Flange construction
 International standard interface ISO, NG6
 Designation of symbols acc. to table

Nominal volume flow Q_N	5 l/min	<input type="text" value="5"/>	
	10 l/min	<input type="text" value="10"/>	
	16 l/min	<input type="text" value="16"/>	
	25 l/min	<input type="text" value="25"/>	

Nominal voltage U_N	12 VDC	<input type="text" value="G12"/>	
	24 VDC	<input type="text" value="G24"/>	

Nominal power P_N	9 W	<input type="text" value="L9"/>	<i>Ambient temperature up to:</i> 40 °C or 90 °C
	15 W	<input type="text" value="L15"/>	

Certification	ATEX, UKEX, IECEX, CCC, EAC	<input type="text"/>	
	Australia	<input type="text" value="AU"/>	USA / Canada <input type="text" value="UC-M187"/>
	MA	<input type="text" value="MA"/>	India <input type="text" value="PE"/>

Sealing material	NBR	<input type="text"/>	
	FKM (Viton)	<input type="text" value="D1"/>	

Amplifier

Design index (subject to change)

1.10-88

GENERAL SPECIFICATIONS

Designation	Proportional spool valve
Construction	Direct operated
Mounting	Flange construction
Nominal size	NG6 according to ISO 4401-03
Actuation	Ex-protection proportional solenoid
Ambient temperature	Operation as T6 -25...+40 °C (L9) Operation as T4 -25...+90 °C (L9) -25...+70 °C (L15)
Weight	2,8 kg (1 solenoid) 4,8 kg (2 solenoids)
MTTFd	150 years

ELECTRICAL SPECIFICATIONS

Protection class	IP65 / 66 / 67
Relative duty factor	100 % DF
Voltage tolerance	± 10 % with regard to nominal voltage
Standard nominal voltage	12 VDC, 24 VDC
Limiting current at... °C	L15 / 70 °C: $I_G = 445 \text{ mA}$ ($U_N = 24\text{VDC}$) $I_G = 890 \text{ mA}$ ($U_N = 12\text{VDC}$) L9 / 40 °C: $I_G = 305 \text{ mA}$ ($U_N = 24\text{VDC}$) $I_G = 610 \text{ mA}$ ($U_N = 12\text{VDC}$) L9 / 90 °C: $I_G = 265 \text{ mA}$ ($U_N = 24\text{VDC}$) $I_G = 530 \text{ mA}$ ($U_N = 12\text{VDC}$)
Standard nominal power	9 W, 15 W
Temperature class	Nominal power 9 W: T1...T6 Nominal power 15 W: T1...T4

Note! Other electrical specifications see data sheet 1.1-183

HYDRAULIC SPECIFICATIONS

Working pressure	$p_{max} = 350 \text{ bar}$
Tank pressure	$p_{Tmax} = 160 \text{ bar}$
Maximum volume flow	$Q_{max} = 35 \text{ l/min}$, see characteristics
Nominal volume flow	$Q_N = 5 \text{ l/min}$, 10 l/min, 16 l/min, 25 l/min
Leakage oil	On request
Hysteresis	L15 / 70°C: $\leq 10 \%$ at optimal dither signal L9 / 40°C: $\leq 12 \%$ at optimal dither signal L9 / 90°C: $\leq 14 \%$ at optimal dither signal
Fluid	Mineral oil, other fluid on request
Viscosity range	12 mm ² /s...320 mm ² /s
Temperature range fluid	Operation as T6 NBR -25...+40 °C (L9) FKM -20...+40 °C (L9) Operation as T4 NBR -25...+70 °C (L9 or L15) FKM -20...+70 °C (L9 or L15)
Contamination efficiency	Class 18 / 16 / 13
Filtration	Required filtration grade $\beta_{6...10} \geq 75$, see data sheet 1.0-50

MANUAL OVERRIDE

HB4,5 as standard
 Optionally: HN (K)
 → see data sheet 1.1-311

SURFACE TREATMENT

- ◆ The valve body, the armature tube, the slip-on coil, and the screw plug are zinc-nickel coated

STANDARDS

Explosion protection	Directive 2014 / 34 / EU (ATEX)
Flameproof enclosure	EN / IEC / UL 60079-1, 31
Cable entry	EN 60079-0, 1, 7, 15, 31
Mounting interface	ISO 4401-03
Protection class	EN 60 529
Contamination efficiency	ISO 4406

SEALING MATERIAL

NBR or FKM (Viton) as standard, choice in the type code

Attention! With the execution L9 for ambient temperatures up to 90 °C (L9/90 °C), Q_N is not reached

PERFORMANCE SPECIFICATIONS

Oil viscosity $\nu = 30 \text{ mm}^2/\text{s}$

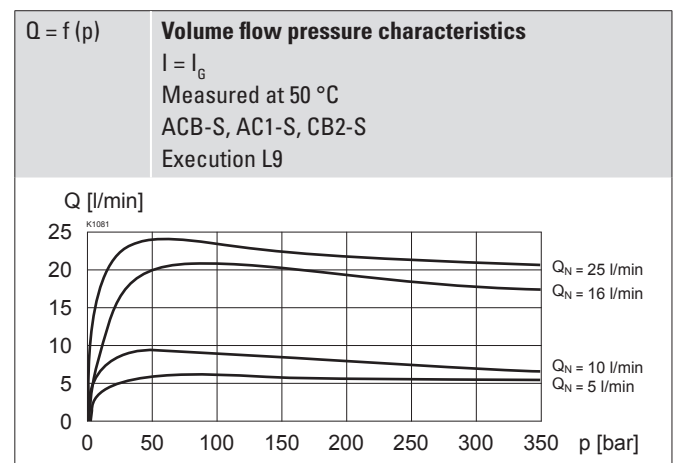
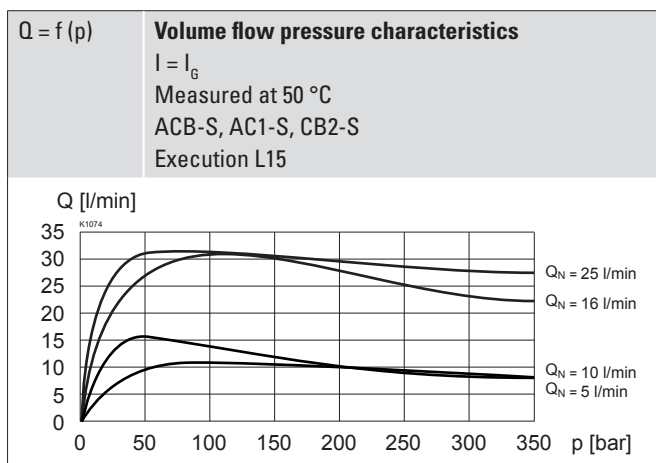

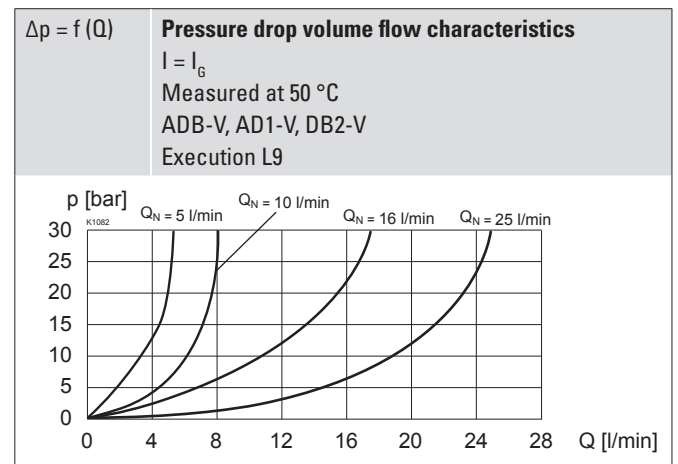
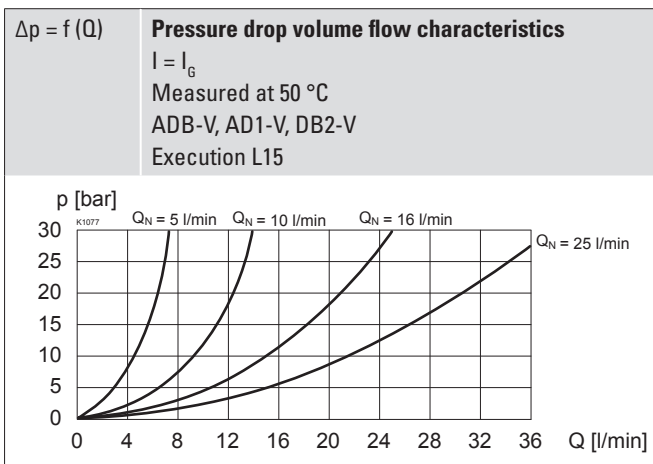
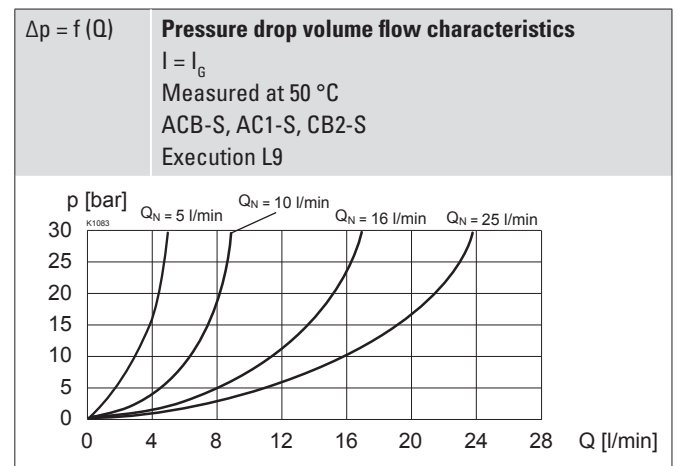
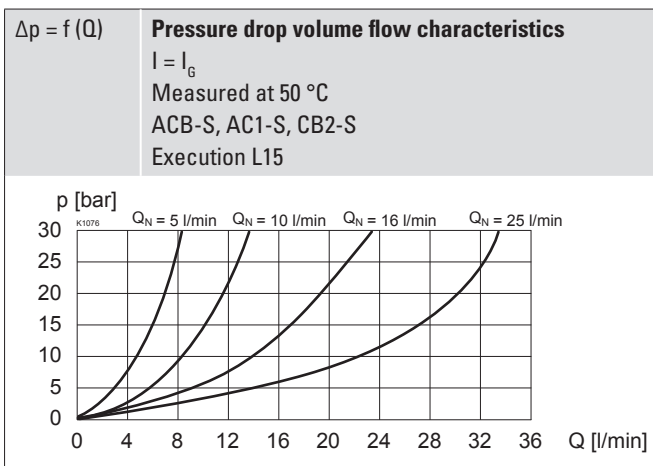
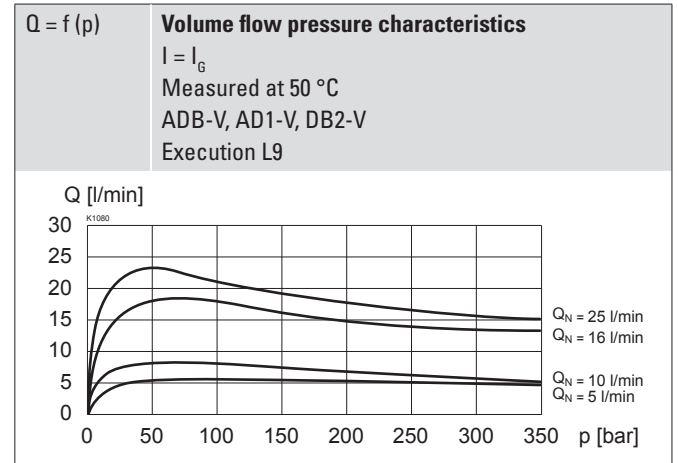
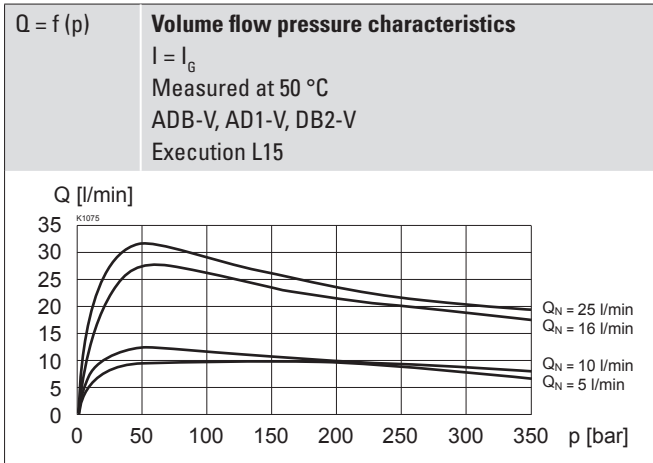

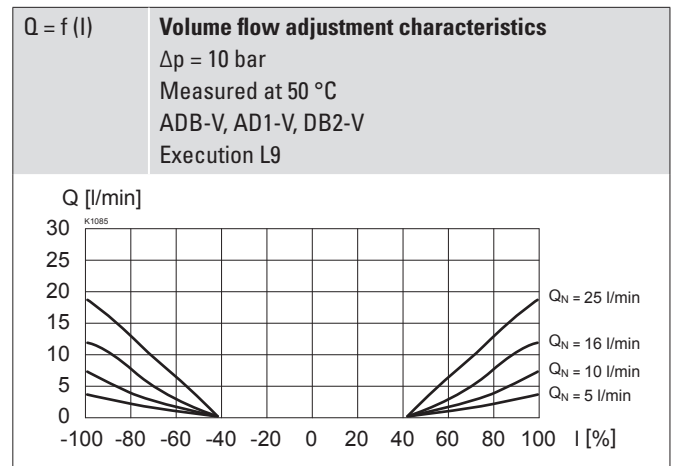
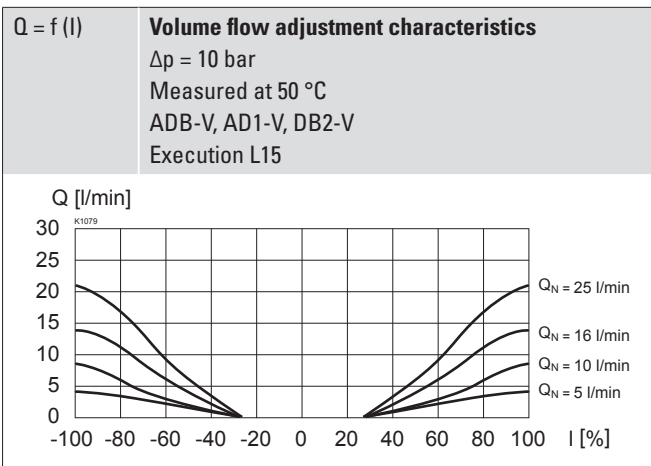
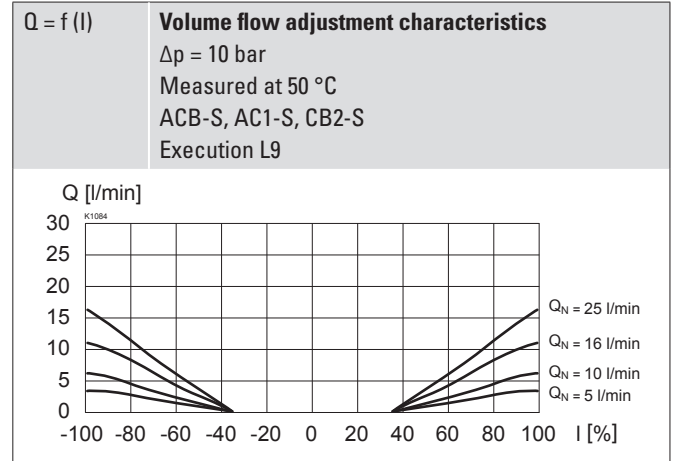
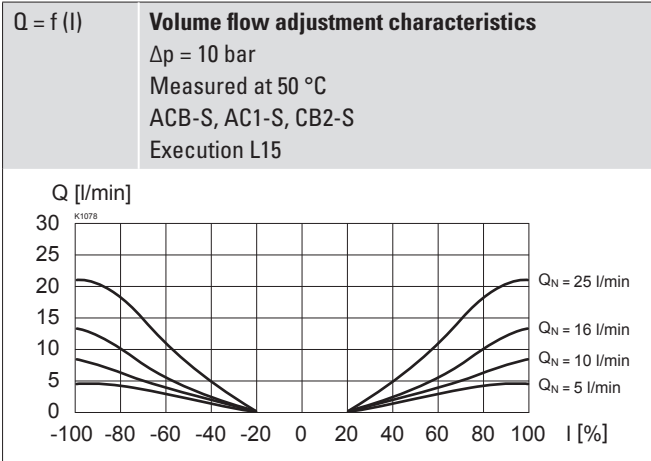

Note!



All values were measured over two control edges. The connections A and B were short-circuited.

DIMENSIONS

4/2-way spool valve

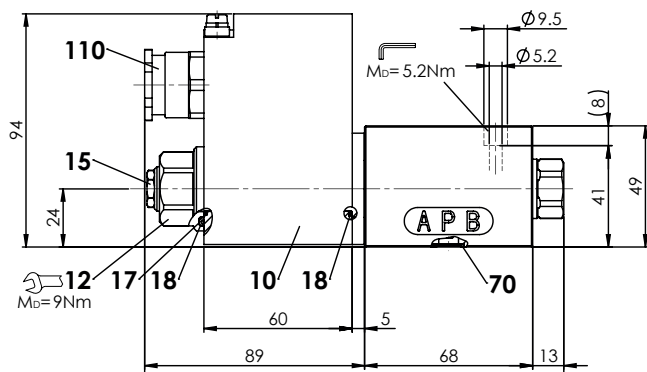

Dimensions of the solenoid coil, refer to data sheet 1.1-183 and 1.1-184

4/3-way spool valve

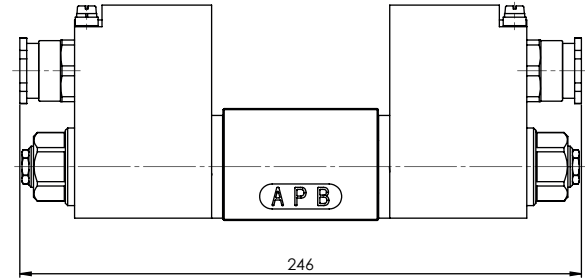

HYDRAULIC CONNECTION

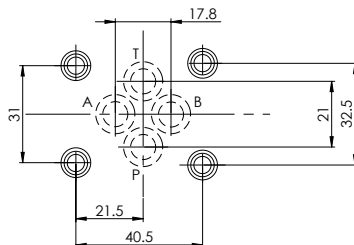

PARTS LIST

Position	Article	Description
10	263.6...	Solenoid coil MK.45 / 18 x 60
12	154.2603	Knurled nut Ex M18 x 1,5 x 18
15	253.8000	Manual override HB4,5
110	111.1080	Cable gland M20 x 1,5
		Seal kit WDYFA06, WDBFA06

Seal kit consisting of:

17	O-ring	ID 25,07 x 2,62
18	O-ring	ID 17,17 x 1,78
70	O-ring	ID 9,25 x 1,78

INSTALLATION NOTES

Mounting type	Flange mounting 4 fixing holes for socket head screws M5 x 50
Mounting position	Any, preferably horizontal
Tightening torque	Fixing screws $M_D = 5,2 \text{ Nm}$ (screw quality 8.8, zinc coated) $M_D = 9 \text{ Nm}$ knurled nut

Note! The length of the fixing screw depends on the base material of the connection element.



Attention! For stack assembly please observe the remarks in the operating instructions



ACCESSORIES

Proportional amplifier	Register 1.13
Threaded subplates	Data sheet 2.9-30
Multi-station subplates	Data sheet 2.9-60
Module type manifold blocks	Data sheet 2.9-100
Technical explanations	Data sheet 1.0-100
Filtration	Data sheet 1.0-50
Relative duty factor	Data sheet 1.1-430